

New Baseband Radio Channel Impulse Processing Algorithms

V. Wieser, N. Majer, J. Haring

Department of Telecommunications and Multimedia, University of Zilina,
Zilina, 01026, Slovak Republic, phone: +421 (41)5132260, e-mail: vladimir.wieser@fel.uniza.sk

Introduction

A radio signal (RF signal) travels by multiple paths in radio channel to antenna receiver and is created by an interference of several copies of transmitted signal, which reflect from subjects that are placed in surrounding environment. This effect will cause, that each replica of RF signal will have a different amplitude, phase and delay, so delay spread and intersymbol interference (ISI) will emerge [1,2].

By estimation of quantity, amplitudes, phases and delays of dominant paths it is possible to describe the pulse response of radio channel. This information may be used to adapt bit rate, transmitter power, beam pattern of smart antenna and weights of Rake receiver [3].

In the present, methods used for the estimation of the channel pulse response apply a hardware solution, so called channel sounders [4], which process the received signal in RF band.

Complex receivers, a low flexibility for received signal processing are the main disadvantages of this solution. With hardware signal processing, the receiver is designed for dealing with a specific signal and any change of RF signal will cause a necessity to receiver change.

The solution of this problem is possible by a combination of six-port reflectometer technique (SPR) used for baseband conversion and a Software Defined Radio (SDR) [5]. In this system any change of RF signal is possible to be solved by change of the processing algorithm only.

RF Signal Processing

The processing of RF signals is too complex in high-frequency bands and digitizing of RF signal is complicated in the present, because of A/D converters, which are able to digitize signals only to tens of MHz with satisfactory dynamic resolution [11]. The solution of this problem lies in baseband real time signal conversion and its subsequent software analysis [6].

We are using the six-port reflectometer [7] (Fig.1.) for RF signal baseband conversion. RF signal received by antenna is led to SPR, where a standing wave is created by

interference of RF signal with signal from local oscillator (LO). Standing wave is detected by a four power detectors (diodes) D1-D4, which are connected to A/D converters. The signal is digitized by A/D converters in the baseband and is processed by appropriate algorithms.

More details about SPR technology may be found in [8].

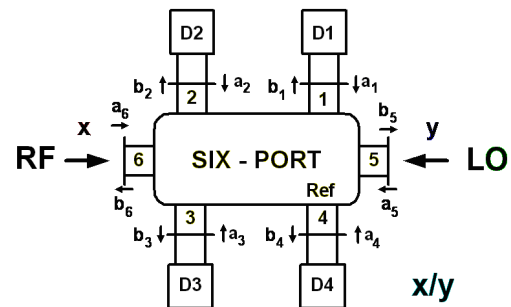

Fig. 1. Six-port reflectometer

The diode D_1 is in the input of SPR and detects only traveling wave of the received signal. Other diodes D_2 , D_3 , D_4 detect only standing wave, which is created due to interference of two waves, the received one and the wave from the local oscillator (Fig. 1) [8].

The principle of SPR receiver with baseband conversion may be described as follows.

The input signal

$$x(t) = \left[\sum_{i=1}^K \beta_i(t) M(t - \tau_i) \exp(j\psi_{0i}) \right] \exp(j\omega_0 t), \quad (1)$$

where $M(t)$ – modulation signal (one signal pulse in the baseband), τ_i – the delay along the i -th path, $\beta_i(t)$ – fading along i -th path represented by time varying random process with Rayleigh distribution, ψ_{0i} – i -path carrier phase, ω_0 – carrier frequency, K – number of paths ($1 \leq K \leq 6$).

The signal from local oscillator

$$y(t) = Y_0 \exp(j\omega_0 t). \quad (2)$$

The final signal

$$v(t) = x(t)/y(t) = \frac{1}{Y_0} \sum_{i=1}^K \beta_i(t) M(t - \tau_i) \exp(j\psi_{oi}), \quad (3)$$

$$v(t) = \sum_{i=1}^K M(t - \tau_i) \cdot \delta_i(t), \quad (4)$$

where $\delta_i(t)$ – a complex number for i -th path calculated by six-port reflectometer and representing the amplitude and phase of down-converted signal [9].

Properties estimation of channel pulse response

For estimation purposes we have used the model of macrocellular outdoor mobile Rayleigh fading channel (MRFC), consisting of 6 paths and corrupted by AWGN [1]-[10]. The sounder is transmitting single real estimation pulse with $T_i = 10$ ns and relative amplitude equal 1 ($M(t) = 1$) through MRFC channel.

We created four algorithms for estimation of radio channel pulse response properties. An algorithms' task is the estimation of basic propagation paths parameters – amplitude, phase and delay of signals in each path.

The principle of proposed algorithms lies in the processing of channel pulse response in time domain. Incoming signal samples are stored in the memory bank and then compared with consecutive samples.

Power Descend Algorithm

PDA algorithm (Power Descend Algorithm) compares samples incoming in time t , $v(t)$ with the ones incoming in time $t+1$, $v(t+1)$. If

$$\begin{cases} v(t) > v(t+1) \text{ then } v(t) = v_{\max}(t), \\ v_{\min}(t) = v(t+1). \end{cases} \quad (5)$$

The PDA algorithm calculates a constant descent d_c , which represents the difference between amplitudes of two consecutive samples (t and $t-1$):

$$d_c = v_{\max}(t) - v_{\min}(t). \quad (6)$$

Then PDA algorithm compares calculated constant descent with the required one, d_r and if a condition $d_c > d_r$ is true, then algorithm evaluates this descent as the propagation path (square) (Fig. 2) and stores amplitude, phase and delay of this path.

Repeating of this process is finished by all propagation paths finding (Fig. 2).

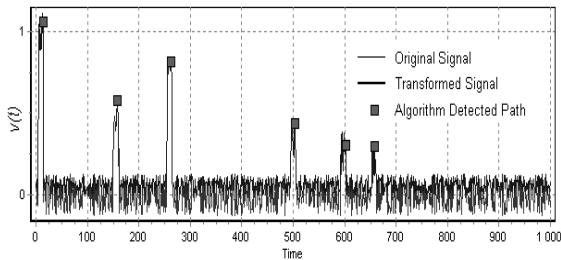

Fig. 2. Radio channel pulse response and indication of paths detected by PDA algorithm

The value of required constant descent d_r designates a resolving ability of PDA algorithm. With higher values d_r , PDA algorithm finds the paths with bigger amplitude (dominant paths) only.

Because samples of incoming signal are directly written to variable $v_{\min}(t)$, the incoming signal is identical with a generated one (Fig.2), which is the main disadvantage of PDA algorithm. Therefore, PDA algorithm frequently assigns a noise as the propagation path (Fig.2).

Rectangular Window Function Algorithm

RWFA algorithm (Rectangular Window Function Algorithm) is designed on the same principle as the previous one, but with difference, that if the RWFA algorithm finds a local maximum, this value is hold on the same level during interval $t+\Delta t$ (width of the transmitted measurement pulse). If

$$\begin{cases} v(t) > v(t+1) \text{ then } v(t) = v_{\max}(t), \\ v_{\min}(t) = v_x(t + \Delta t + 1). \end{cases} \quad (7)$$

The actual value of the signal amplitude $v(t+\Delta t+1)$ (Fig.3) is written to the variable $v_{\min}(t)$ after the interval elapsed.

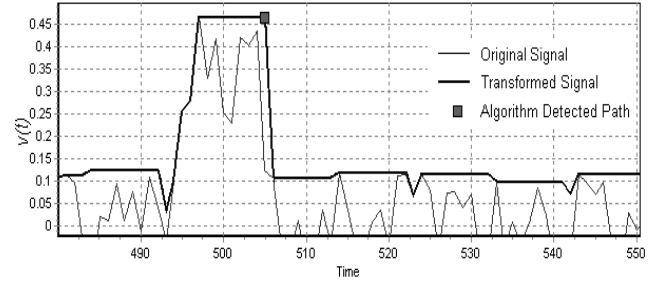

Fig. 3. Rectangular Window Function Algorithm RWFA

To identify individual paths of channel pulse response, the RWFA algorithm achieves better results as the previous one, but it is inappropriate in the radio channel with low signal to noise ratio (SNR) (Fig.4).

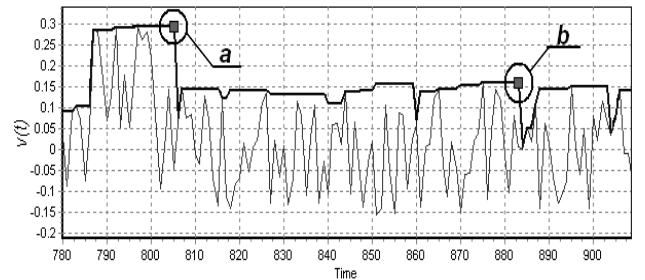

Fig. 4. a) correct b) incorrect indication of propagation path by RWFA algorithm

Exponential Power Descend Algorithm

The EPDA algorithm (Exponential Power Descend Algorithm) is different from the previously described algorithms. The signal is descending by exponential function from local maximum and signal samples are

written to variable $v_{min}(t)$ (Fig.5). If

$$\begin{cases} v(t) > v(t+1) \text{ then } v(t) = v_{\max}(t), \\ v_{\min}(t) = v(t) \cdot \exp[-\alpha(t)], \end{cases} \quad (8)$$

where α – the power descent constant.

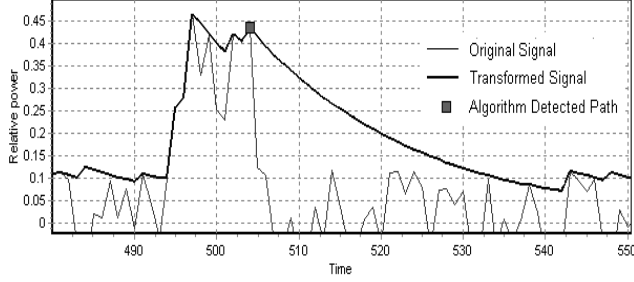

Fig. 5. Exponential Power Descent Algorithm EPDA (detail)

In reality, this algorithm doesn't work with original signal envelope, but with envelope of a transformed signal (Fig.5, 6).

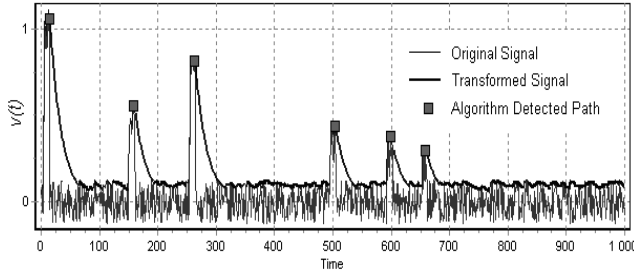

Fig. 6. Exponential Power Descent Algorithm EPDA

By this processing, the EPDA algorithm achieves much better results as previously described algorithms and the run time is not increased.

Modified Exponential Power Descend Algorithm

MEPDA algorithm (Modified Exponential Power Descend Algorithm) is slightly more demanding for run time and achieves only a little bit better results as EPDA algorithm. The difference between both algorithms lies in using a modified exponential function, describing the signal descends from local maximum (Fig.7).

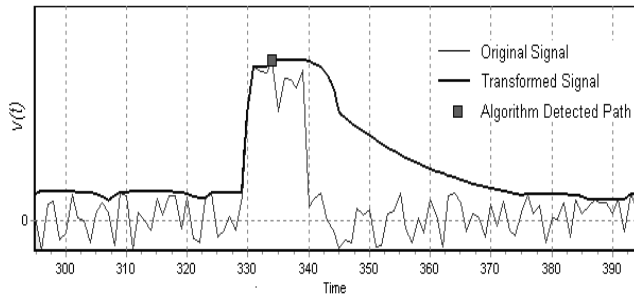

Fig. 7. Modified Exponential Power Descend Algorithm MEPDA

Comparison of algorithms

To compare proposed algorithms, a new program was created, which generates the channel pulse response of MRFC channel and compares a true quantity of paths with the quantity found by individual algorithms:

$$N_f(i) \leq N_g(i) \text{ then } P_r(i) = \lfloor N_f(i) / N_g(i) \rfloor \cdot 100, \quad (9)$$

$$N_f(i) > N_g(i) \text{ then } P_{fa}(i) = \lfloor N_g(i) / N_f(i) \rfloor \cdot 100, \quad (10)$$

where N_f – the number of paths found by algorithm, N_g – the generated number of paths, $P_r(i)$ – the probability of all paths recovery for one pulse response, $P_{fa}(i)$ – the probability of false alarm and i – the repetition number for one SNR value.

The number of generated pulse responses was chosen to 1 000 for one SNR value. The value of SNR varied from 0 dB to 15 dB by 0.1 dB step. The probability of all paths recovery P_{SNR} for given value of SNR:

$$P_{SNR} = \left[\sum_{i=1}^{1000} P_r(i) \right] / 1000 \text{ [\%]}. \quad (11)$$

The CDF of P_{SNR} is displayed on Fig. 8.

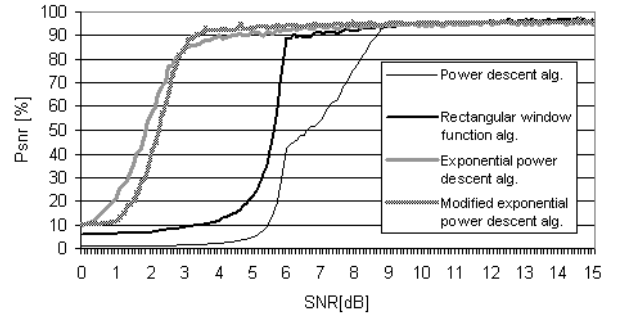

Fig. 8. The CDF of paths recovery probability

Setting the recovering paths probability to 90 %, it is obvious (Fig. 8) that PDA algorithm reaches the worst results (required SNR = 9 dB). The RWFA algorithm reaches the requested value of P_{SNR} approximately with SNR = 6 dB. The best results were achieved by EPDA and MEPDA algorithms, SNR = 3 dB.

The EPDA algorithm was selected for the next application, because of its short run time and good behavior of cumulative distribution function curve (Fig. 8).

Results of the EPDA algorithm are dependent on power descent constant α . The distribution functions of EPDA algorithm for different values α in dependence on SNR values are shown on Fig. 9.

From Fig. 9 it is obvious, that EPDA algorithm reaches a recovery successfulness of all paths with value approximately 83 %, even with SNR = 0 dB ($\alpha = 1.01$). The recovery successfulness of all paths is greater than 90 % for values $\alpha > 1.01$, but SNR values have to be higher. The value $\alpha = 1.025$ appears to be optimal one, for which the algorithm reaches $P_{SNR} \approx 90$ % with necessary value of SNR = 2.5 dB. The P_{SNR} is approximately 95 % for SNR > 2.5 dB.

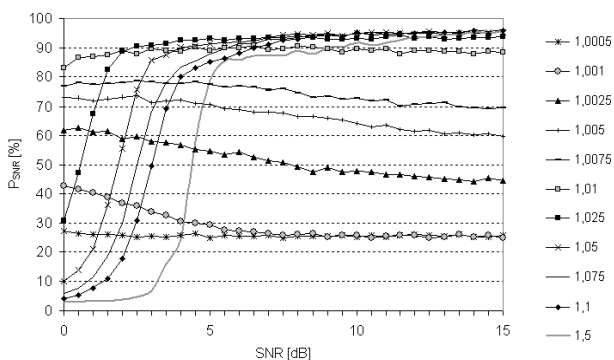

Fig. 9. The performance of EPDA algorithm with different α values

Conclusion

In this contribution the method for dominant parameters estimation of radio multipath channel pulse response with baseband conversion by six-port reflectometer technique is described. The proposed method uses the six-port technique for baseband conversion and signal processing is realized by algorithms implemented in software defined radio. The Exponential Power Descend Algorithm is the most perspective, because achieved recovery successfulness of all signal paths is approximately 90 % for SNR \approx 2.5 dB.

Acknowledgements

This paper was supported by the scientific grant agency VEGA in the projects No. 1/4067/07, 1/4065/07 and by Slovak Research and Development Agency under the contract No. APVV-0448-06.

References

1. **Janaswamy E.** Radiowave propagation and smart antennas for wireless communications. – 2001. – Kluwer Academic Pb.
2. **Schwartz L., Hottmar V. and Trstenský D.** End User Box for Interactive Cable Television // IEEE Transactions on Consumer Electronics. – 2007. – Vol. 53, No. 2. – P. 412–416.
3. **Gallagher T. M.** Characterization and Evaluation of Non-Line-of-Sight Paths for Fixed Broadband Wireless Communications / Ph.D. dissertation. – Faculty of the Virginia Polytechnic Institute. – 2003.
4. **Trautwein U., Hampicke D., Sommerkorn G., Thoma R.** Array Based Measurements of the Time-Variant Directive Radio Channel // European Microwave Conference. – Munich. – 1998.
5. **Hickling R.** New Technology Facilitates True Software Defined Radio. – 2005. – Accessed at: <http://rfdesign.com/mag/504rfdfl.pdf>.
6. **Marsan E., Bosio G.R. and Wu K. A.** C-Band Direct Digital Receiver MMIC and its Carrier Recovery Circuit. – Montreal: Poly-GRAMES Research Centre, 2002.
7. **Majer L., Stopjaková V.** Monolithic RF receiver in 2GHz frequency region using six-port technology // Proceedings of IEEE. – Vršov. – 2006.
8. **Bilík V.** Six-port Measurement Technique: Principles, Impact, Applications. Accessed at: www.s-team.sk/download/SixPortTechnique.pdf.
9. **Kerneves D.** Direction finding with six-port reflectometer array // The 8th COST 260 Management Committee Meeting. – Rennes. – 2000.
10. **Doboš L., Dúha J., Marchevský S., Wieser V.** Mobile Radio Networks. – University of Žilina. – EDIS Pb. – 2002.
11. **Kvedaras R., Kvedaras V.** Investigation of Digital Signal Processing for Measurement of Dynamic Parameters of High-Speed DAC's // Electronics and Electrical Engineering. – Kaunas: Technologija, 2008. – No. 3(83). – P. 11–14.

Received 2009 02 25

V. Wieser, N. Majer, J. Haring. New Baseband Radio Channel Impulse Processing Algorithms // *Electronics and Electrical Engineering*. – Kaunas: Technologija, 2009. – No. 7(95). – P. 11–14.

The method for radio channel pulse response processing with baseband conversion by six-port reflectometer technique is described. The received signal is converted by baseband conversion, digitized and the pulse response of radio channel is processed by proposed algorithms. These algorithms are working in real time and are able to estimate the amplitude, phase and delay of the received signal in each of propagation paths. The most promising algorithm (Exponential Power Descend Algorithm) achieved recovery successfulness of all signal paths equal approximately 90 % for SNR = 2.5 dB. Ill. 9, bibl. 11 (in English; summaries in English, Russian and Lithuanian).

В. Весер, Н. Маер, Ю. Харинг. Новый алгоритм обработки импульсной реакции каналов // *Электроника и электротехника*. – Каунас: Технология, 2009. – № 7(95). – С. 11–14.

Описывается алгоритм обработки импульсной реакции, когда основной диапазон канала конвертирования сигналов осуществляется шестиканальным рефлектометром. Импульсная реакция радиоканала рассчитывается новым алгоритмом. Данный алгоритм позволяет определить амплитуду, фазу и задержки в каждом канале. Вероятность восстановления сигналов составила около 90%, когда SNR = 2,5 дБ. Ил. 9, библи. 11 (на английском языке; рефераты на английском, русском и литовском яз.).

V. Wieser, N. Majer, J. Haring. Naujas impulsinės kanalų reakcijos apdorojimo algoritmas // *Elektronika ir elektrotechnika*. – Kaunas: Technologija, 2009. – Nr. 7(95). – P. 11–14.

Aprašomas radijo kanalo impulsinės reakcijos apdorojimo metodas, pagrįstas bazinio diapazono keitimu naudojant šešių kanalų reflektometrą. Priimtas signalas keičiamas, skaitmeninamas, o impulsinė radijo kanalo reakcija apskaičiuojama taikant pasiūlytus algoritmus. Šie algoritmai skirti duomenims apdoroti realiu laiku ir jais galima nustatyti priimto signalo amplitudę, fazę ir vėlinimą kiekviename kanale. Nustatyta, kad perspektyviausias yra eksponentinio galios mažėjimo algoritmas. Jį naudojant visuose signalo sklaidimo kanaluose sėkmingo informacijos atkūrimo tikimybė siekė apytiksliai 90 %, kai SNR = 2,5 dB. Il. 9, bibl. 11 (anglų kalba; santraukos anglų, rusų ir lietuvių k.).

DOI: 10.5755/j02.eie.9988