

## SIMULATION

## MODELIAVIMAS

## Remote Quanser Experiments

**D. Popescu, C. Ionete, D. Sendrescu, M. Roman**

*Department of Automation and Mechatronics, University of Craiova,  
107 Decebal Blvd., Craiova, Romania, phone: +40251436999, e-mail: dorinp@robotics.ucv.ro*

### Introduction

Laboratory work is an important part of engineering education. The laboratory experiments expose students to experimentation and challenge them to examine cause and effects relationships related to physical phenomena. This hands-on discovery-based learning can only be approximated with the delivery methods currently used for online classes. There are two kinds of remote or distance training: the lecture-based training and the laboratory-based training. Lecture-based courses are taught at many institutions using video taped lectures, live compressed video, television broadcasts or radio broadcasts [1–5]. Laboratory-based training is typically conducted remotely using software running on a host computer.

Some programs simulate hands-on experimentation where the student remotely controls equipment over the Internet. This online experimentation can be used to visualize and to perform some real experiments with better results than the simulated one.

Other programs offer condensed laboratory courses on campus. This type of on-campus experimentation is an effective hands-on learning methodology. However, it is difficult to retain material presented during a short, intensive on-campus training session offered in some distance programs. Using only live or taped video to deliver course content does not give students adequate hands-on training. The delivery of a hands-on remote or distance laboratory requires a different approach. The course must engage the students with active hands-on learning but must not restrict the student who is time and place bound. The challenge is to design a course that is an equal or better learning experience than the traditional in-class laboratory course.

The goal of our remote or distance laboratory was to develop the same critical skills in the distance setting as are developed in the in-class laboratories. Our laboratory tasks stress experimental design, prototype development and technical documentation. We designed each remote laboratory activity to consist of online information in the form of text, pictures, and diagrams as well as hands-on experiments conducted at home, online video and interactive control of the parameter of the real plant.

### Hardware equipment

The experiments cover experiments based on the rotary servo and experiments based on linear motion. The design software is written in MATLAB/SIMULINK environment.

In our remote laboratory the following experiments are available: rotary flexible link, rotary inverted pendulum, rotary ball and beam, rotary and linear position servo, linear flexible joint, linear inverted pendulum.

The main components to focus on in connecting the Rotary and Linear Quanser experiments are the Power Module, the DS1104 Interface Board, and the servo rotary motor. With these elements, plus the necessary interface cables, the users are able to run most of the plants that were designed by Quanser. Two of these experiments - Rotary Inverted Pendulum and Flexible Link - are shown in the Fig. 1 and Fig. 2.

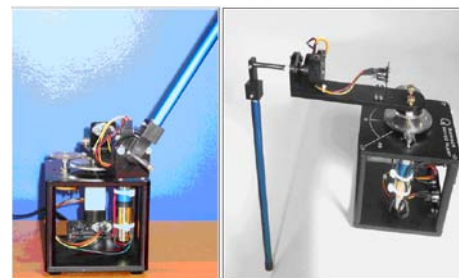

Fig. 1. Rotary inverted pendulum

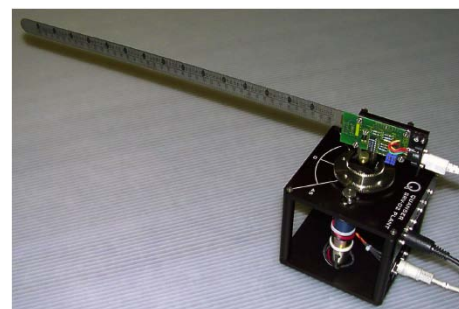

Fig. 2. Flexible Link

The Universal Power Module realizes the power adaptation between the Quanser PC board and the servo rotary motor which drives the inverted pendulum.

The Rotary Inverted Pendulum [6] offers the student the opportunity to balance a vertical rod by manipulating the angle at the base. This is the classical pendulum problem only now the trajectory is circular. This module is also configurable in 3 distinct configurations. The module can be used as a classical inverted pendulum, a gantry crane or in the self-erecting inverted pendulum.

The objective of the laboratory work is to design a feedback controller such that the Quanser experiment/module tracks a desired command while minimizing some requirements, such as link deflection and resonance in the system for Flexible Link module [7]. The user may design any controller he/she wishes [8–10].

### Software tools

WinCon is a real-time Windows 98/NT/2000/XP application [11]. It allows you to run code generated from a Simulink diagram in real-time on the same PC (also known as local PC) or on a remote PC. Data from the real-time running code may be plotted on-line in WinCon Scopes and model parameters may be changed on the fly through WinCon Control Panels as well as Simulink. The automatically generated real-time code constitutes a stand-alone controller (i.e. independent from Simulink) and can be saved in WinCon Projects together with its corresponding user-configured scopes and control panels. WinCon software actually consists of two distinct parts: WinCon Client and WinCon Server. They communicate using the TCP/IP protocol. WinCon Client runs in hard real-time while WinCon Server is a separate graphical interface, running in user mode.

WinCon supports two possible configurations: the local configuration (i.e. a single machine) and the remote configuration (i.e. two or more machines). In the local configuration, WinCon Client, executing the real-time code, runs on the same machine and at the same time as WinCon Server (i.e. the user-mode graphical interface). In the remote configuration, WinCon Client runs on a separate machine from WinCon Server. The two programs always communicate using the TCP/IP protocol. Each WinCon Server can communicate with several WinCon Clients, and reciprocally, each WinCon Client can communicate with several WinCon Servers.

The local configuration, one-task network configuration and multi-task network configuration are shown below in Fig. 3, Fig. 4 and in Fig. 5. The data acquisition card, in this case the MultiQ PCI, is used to interface the real-time code to the plant to be controlled. The user interacts with the real-time code via either WinCon Server or the Simulink diagram. Data from the running controller may be plotted in real-time on the WinCon scopes and changing values on the Simulink diagram automatically changes the corresponding parameters in the real-time code. The real-time code, i.e. WinCon Client, runs on the same PC. However, the real-time code takes precedence over everything else, so hard real-time performance is still achieved.

xPC Target is a solution to test the real-time applications using a personal computer (PC). xPC target is based on an architecture which uses a target PC, different from host PC on which is developed the real-time application.

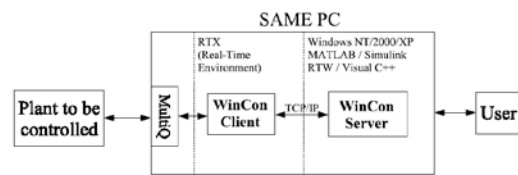

Fig. 3. The local configuration

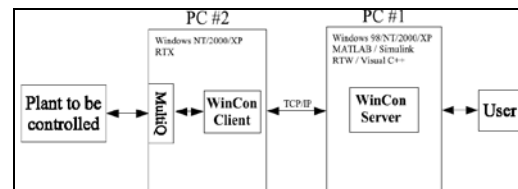

Fig. 4. Remote one-task configuration

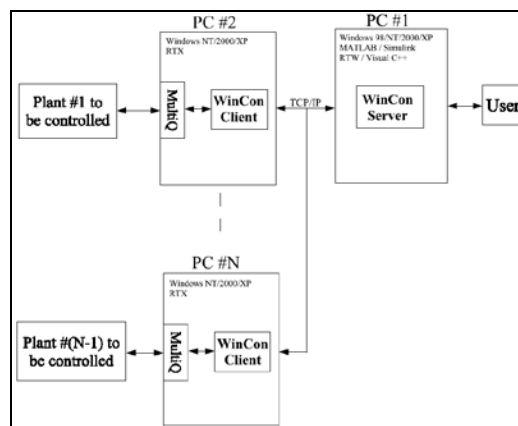

Fig. 5. Remote multi-task network configuration

In this testing framework, a PC desktop can be used as host PC together with MATLAB, Simulink, and Stateflow (optional), in order to create a model using Simulink tools and Stateflow diagram. After the creation of the model it can be tested through simulation (nonreal time).

xPC Target allows to add inputs/outputs blocks to the created model and then the new model can be used on the host PC together with Real-Time Workshop, Real-Time Workshop Embedded Coder (optional), Stateflow Coder (optional), and C/C++ compiler in order to create .exe code. Exe code is downloaded from host computer on target computer which runs the real-time xPC Target kernel. After the exe code downloading, this can be launched and tested on target computer as a real-time application. xPC target represents a Matlab/Simulink/RTW facility very useful for testing of real-time embedded applications.

xPC Target doesn't need DOS, Windows, Linux, or another operating system on the target computer. Instead of the operating system, the target computer is booted up using a floppy disk which contains xPC Target kernel.

xPC Target uses two types of connections and communication protocols: serial and network (Fig. 6 and Fig. 7).

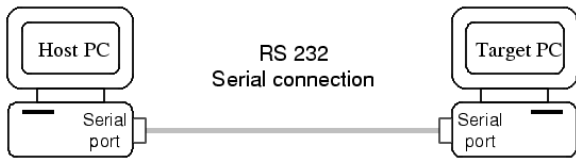

Fig. 6. Serial connection

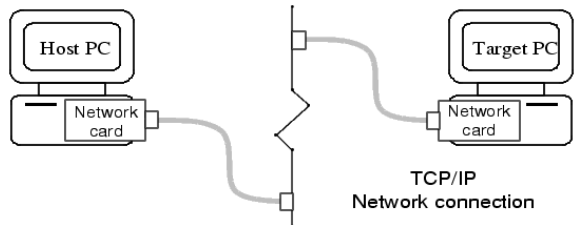

Fig. 7. Network connection

### The remote laboratory

The following presents our experiences in developing a remote or distance laboratory and should help guide others in efforts to deliver successful remote laboratory experiences.

The architecture of the remote laboratory is presented in Fig. 8. The real equipments/modules used in the remote laboratory work are presented in Fig. 9.

In order to provide a distance-learning environment that is as engaging as the traditional in-class laboratory, the training documentation was delivered using a variety of media. Each laboratory was designed to have one or more of the following fundamental components: an Exercise-Lab, a Lab-Kit and a Lab-Test. The Exercise-Lab components consist of a series of computer and Internet-related exercises. The Lab-Kits are small, transportable experiments that the students receive through the mail.

The Lab-Test is a traditional hands-on component in which students perform some of the more complicated experiments at the university or at an educational center under direct supervision of a mentor. Because each laboratory is different, some experiments are performed entirely over the Internet, while others have major hands-on components.

The remote online experiment consists in a control system design and test using the real plants from our laboratory. The tasks for students can be divided in three steps:

1. After answering a few questions and viewing online (via Internet) the real plant that must be controlled, the student has to get a model of the plant that has to control using the online documentation about the experiment. For the more complex systems, the differential equations are derived using MAPLE V (mathematical manipulation computer language) after which the linear models are imported to MATLAB.

2. Using the model obtained to step 1, the student has to design a controller such as the close-loop system to achieve some imposed performances. The controller is designed using the MATLAB/SIMULINK software.

3. Download the designed controller on the target computer that is directly connected to the experiment and

to test the designed control system in real-time. Before performing any experiments, the student should read the associated section for the experiment and understanding its purpose.

The experiments occupation is controlled using an online timetable.

After completing the online activity, the student is directed to post a comment or question on the discussion group that pertains to the experiment. The discussion group provides an opportunity to share ideas with peers, confirm results, and receive answers to questions.

The results from our development and initial course offerings indicate that student learning is at least equivalent to our traditional laboratory class. The asynchronous nature of a distance education experience places extra demands on faculty time.

The remote experiments are also very useful for PhD students and post-university students and for the researcher from other universities.

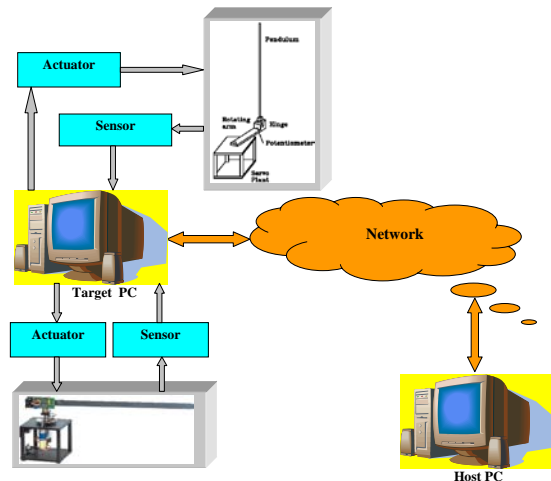

Fig. 8. Architecture of the remote laboratory



Fig. 9. The remote laboratory

### Conclusions

The advances in computers and those resulting from the society of information provide new means for the improvement of training technologies. The remote laboratory was successful in introducing engineering concepts, developing hands-on skills, and motivating

students to become independent learners. The training documentation was presented using various modes: text, graphics, computer simulations and online instrumentation. Because of the multi-media presentation of the experiments, the activities kept students engaged while learning the necessary engineering concepts. Most of the laboratories had a hands-on component in the form of a Lab-Kit. The Lab-Kit activities required students to work independently. Allowing the students to work through the Lab-Kit activities on their own gave them extra time with the equipment in a safe learning environment. Because they were required to do much of the work themselves, they had to rely on their own assertiveness to find answers to their questions. This structure helped the students to develop strong independent learning skills. In addition, allowing the student this flexibility gave rise to greater risk taking and time to experiment than is ordinarily available in a traditional laboratory.

The success of this remote activity demonstrates how the Internet can be used to deliver a quality hands-on laboratory course at a distance. The rotary and linear Quanser experiments and WinCon and Matlab/Simulink software provide the necessary hands-on component of the remote laboratory. These activities would not have had the same benefits had they been strictly computerized simulations.

Delivering the course content asynchronously allowed greater flexibility for the student. The students complete the assignments at a time most convenient for the students' schedules. This is extremely important for many students who have to balance a career and sometimes a family while striving to complete a degree program.

## References

1. **Campbell J. O., et al.** Using computer and video technologies to develop interpersonal skills // *Computers in Human Behavior*, 1995. – No. 11(2). – P. 223–239.
2. **Doherty P. B.** Learner control in asynchronous learning environments // *Asynchronous Learning Networks Magazine*, 1998. – No 2(2).
3. **Fulkerth R., Stevenson W. W.** Teaching for effectiveness in on-line courses // *Proceedings of the Syllabus Technology for Higher Education 97 Conference*. – Rohnert Park, California, 1997.
4. **Panitz T.** Will You Still Be Teaching In The Twenty First Century? // *Conference Proceedings, Re-organizing Knowledge: Trans-forming Institutions and the University in the XXI Century*. – University of Massachusetts, Amherst, 1999.
5. **Purcell-Roberston R. M., Purcell D. F.** Interactive distance learning. Chapter II // *Distance Learning Technologies: Issues, Trends and Opportunities*. Hershey. – PA: IDEA Publishing Group, 2000.
6. Rotary Inverted Pendulum Experiment. [Online: [www.quanser.com](http://www.quanser.com)].
7. Flexible Link Experiment ROTFLEX. [Online: [www.quanser.com](http://www.quanser.com)].
8. **Ionete C.** LQG/LTR Controller Design for Flexible Link Quanser Real-time Experiment // *Proceedings of the International Symposium on System Theory (SINTES11)*. – Craiova, Romania, 2003. – Vol. 1. – P. 49–54.
9. **Ionete C.** LQG/LTR Controller Design for Rotary Inverted Pendulum Quanser Real-Time Experiment // *Proceedings of the International Symposium on System Theory (SINTES11)*. – Craiova, Romania, 2003. – Vol. 1. – P. 55–60.
10. **Skogestad S., Postlethwaite I.** *Multivariable Feedback Control, Analysis and design*. – John Willey & Sons, 1995.
11. WinCon web site. [Online: [www.quanser.com](http://www.quanser.com)].

Received 2010 02 28

**D. Popescu, C. Ionete, D. Sendrescu, M. Roman. Remote Quanser Experiments // Electronics and Electrical Engineering. – Kaunas: Technologija, 2010. – No. 6(102). – P. 163–166.**

This paper describes the implementation and operation of remote control systems working on Quanser experiments implemented to University of Craiova. The experiments cover experiments based on either the rotary servo or on the linear motion. Design software is included with each experiment and is written in MATLAB, Turbo C and Turbo Assembler. For real-time implementation of the control algorithms the Real-Time Workshop, xPC – Target toolbox from Matlab/Simulink environment and Wincon software are used. A communications link connects the host and target computers. The user designs the application on the host computer and download the real-time application to the target PC. The same communications interface is used to pass commands and parameter changes to the target PC. Ill. 9, bibl. 11 (in English; abstracts in English, Russian and Lithuanian).

**Д. Попеску, Ц. Юонете, Д. Сендреску, М. Роман. Дистанционные „Quanser“ эксперименты // Электроника и электротехника. – Каунас: Технологія, 2010. – № 6(102). – С. 163–166.**

Описывается дистанционная система обучения в Крайовском университете. Система освоена на базе „Quanser“ и проверена с использованием ротационных механизмов и линейных движений предприятий. Работа системы осуществлена программными пакетами Time Workshop и PC Wincon. Анализируются особенности системы управления. Ил. 9, библи. 11, табл. X (на английском языке; рефераты на английском, русском и литовском яз.).

**D. Popescu, C. Ionete, D. Sendrescu, M. Roman. Nuotoliniai „Quanser“ eksperimentai // Elektronika ir elektrotechnika. – Kaunas: Technologija, 2010. – Nr. 6(102). – P. 163–166.**

Aprašomos nuotolinio valdymo sistemos, Krajojvos universitete dirbančios su įmonės „Quanser“ eksperimentine įranga. Eksperimentai susiję su rotaciniais servomechanizmais ir linijiniu judėjimu. Kiekviename ekperimente neapsieinama be projektavimui skirtos programinės įrangos. Realiam laikui modeliuoti taikomi programų paketai „Time Workshop“, „xPC Wincon“. Aprašyti valdymo sistemos sąsajos ypatumai. Il. 9, bibl. 11 (anglų kalba; santraukos anglų, rusų ir lietuvių k.).

DOI: 10.5755/j02.eie.9384