

# Implementation of a New Contactless Piezoelectric Wind Energy Harvester to a Wireless Weather Station

Y. Uzun<sup>1</sup>, S. Demirbas<sup>2</sup>, E. Kurt<sup>2</sup>

<sup>1</sup>*Department of Electrical and Electronics Engineering, Faculty of Engineering, Aksaray University, Aksaray, Turkey*

<sup>2</sup>*Department of Electrical&Electronics Engineering, Faculty of Technology, Gazi University, 06500 Teknikokullar, Ankara, Turkey  
yunusuzun@aksaray.edu.tr*

***Abstract***—A new contactless piezoelectric (PZT) wind energy harvester is constructed and a feasibility study on its power generation mechanism is carried out for a wireless weather station. The new harvester has a magnetic unit enabling to vibrate a PZT layer in a contactless manner. The poles of magnets are oriented in such a way that the tip of the layer is always repelled, when wind rotates the harvester shaft. Therefore the produced magnetic force exerts mechanical bucklings on the layer and this effect produces electricity. After one-year operation, it is clarified that an averaged power of 20  $\mu$ W–60  $\mu$ W can be obtained monthly for the feeding of the station. These results prove that 5 %–18 % of the consumed power of wireless station can be generated by the harvester depending on the wind regime in the region.

***Index Terms***—Contactless, piezoelectric, wind energy, weather station, power.

## I. INTRODUCTION

There is a growing study on long-life power supplied electrical devices such as sensor nodes, unmanned aerial vehicles, and pacemakers [1]–[3]. In addition to these micro structures, macrostructures such as bicycles, shoes, arm and leg connected piezo-powered systems have also been explored [3]–[6]. This proves that as piezo-systems are used for the wireless devices, they have also been used for many applications in nature, industry and human activities [7]–[9]. Easy installation and maintenance, small volume and having cheaper components make the piezo-systems attractive over the large renewable energy resources such as generators, solar panels, etc. Other motivation for the piezoelectric harvesters comes from the lower energy needs as in the wireless sensor nodes. If large powers are not required, piezo-systems giving  $\mu$ W or mW power ranges are the optimal solutions due to the above-mentioned reasons.

Most electrical devices use batteries however this causes some maintenance problems due to the environmental issues and their complex recycling process. In addition, battery

lifetime is limited and one can increase the durability of the power source by different external resources [3],[10],[11]. Therefore an additional renewable energy devices should be attached to these systems in order to charge the batteries or feed the device itself, continuously.

As a renewable energy resource, the energy harvesting systems can convert ambient vibrations into useful electrical energy. There exist a plenty of researches especially in recent years in order to overcome the artifacts of the batteries and the addition of harvesting systems to them [12]–[14]. In this manner, energy harvesting applications can be performed in different sources such as ambient mechanical vibrations, thermoelectric, solar, gas/liquid and wind [15]–[17]. As in many of the researches, the vibrations have been converted to the electrical power easily by using piezoelectric (PZT) materials [18],[19]. Because the conventional solar and wind energy systems have some disadvantages. Strictly speaking, the main disadvantages are dependence to the climate conditions and large installation areas in nature. However, piezoelectric systems are good solutions for such energy conversion due to their easy installations and high energy densities, since they can harvest energy for unsuitable climate conditions such as lower wind speeds or very light rain [17],[20]. The harvested energy per material volume of a piezoelectric is high compared with the conventional solar and wind energy applications. For instance, the wind speeds of our interest are in the range of 1.34 m/s–4.47 m/s due to the fact that the generated force from small blades with the surface area of  $1.3 \times 10^{-3}$ – $3.2 \times 10^{-3}$  m<sup>2</sup> is too small (i.e. smaller than 0.1 N) at these speeds and this condition makes the use of any type of electromagnetic harvester or conventional turbines be impossible [21]. Therefore harvesting energy by the piezoelectric system has some advantages for the feeding of small-scale devices.

The main motivation of the paper is the lack of the sufficient feasibility studies on the usage of piezoelectric harvesters in the wireless weather stations. This paper highlights whether the weather station being far away from any electrical network can be fed at low wind speeds and to which extend the life-span of the battery can be charged via new harvester.

Manuscript received April 21, 2014; accepted September 14, 2014.  
This research was funded by Gazi University - Scientific Research Project Unit under the Project No: BAP 07/2012-12 and EWRES 2013 ERASMUS IP Project (2013-1-TR1-ERA10-48722).

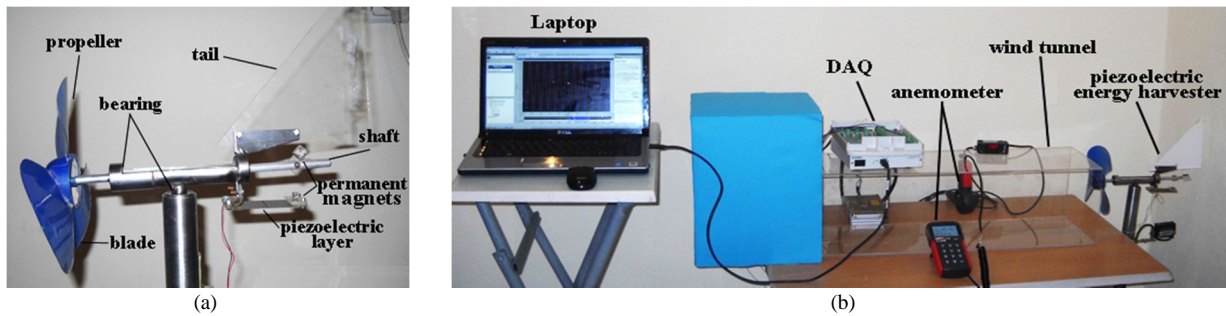

Fig. 1. The wind energy harvester (a); the overall testing system (b).

For this aim, a new contactless piezoelectric wind energy harvester is constructed and applied to a wireless weather station for the feeding of its batteries. The energy generation mechanism is examined for one year period and the output powers of the harvester are determined daily and monthly. The paper is organized as follows: Section II gives a brief explanation on the theory. Some introductory information on the design and construction of new harvester and the preliminary tests in wind tunnel are presented in Section III. Power consumption features of the weather station and operating principles are stated in the next section. Section V discusses the experimental results after the attachment of the harvester to the station. Finally, the concluding remarks are given in the last section.

## II. THEORETICAL BACKGROUND

The theoretical expressions of the proposed harvester can be stated as follows:

$$\frac{d_n}{dt} = \xi, \quad (1)$$

$$m \frac{d^2 r}{dt^2} = ku(t) + rV(t) + f_m u(r - r_0), \quad (2)$$

$$I(t) = r \frac{du(t)}{dt} - C \frac{dV(t)}{dt}, \quad (3)$$

where,  $\xi$ ,  $\xi$ ,  $m$ ,  $r$ ,  $u$ ,  $V$ ,  $f_m$ ,  $r_0$ ,  $C$ ,  $I$  and  $k$  indicate angular position of the magnet, propeller speed, Kronecker delta which gives 1 for  $r = r_0$  else 0, mass of the layer, radial position to center of shaft, mass displacement of layer, force factor of layer, voltage between the layer terminals, magnetic force of magnet, angular position of layer, layer capacitance, harvested current and stiffness constant of the layer, respectively. For a much detailed expression, we refer to our previous studies [11], [14], which includes some identical algebraic formulation.

## III. NEW WIND ENERGY HARVESTER AND PRELIMINARY TESTS

The new wind energy harvester includes four main parts (see in Fig. 1(a)): The propeller which rotates by the wind, the shaft which conveys the rotation effect to the magnets, the piezoelectric part which harvests energy from the mechanical vibration and the electronic part which regulates the harvested electrical signal from the terminals of PZT.

The harvester has two permanent magnets positioned opposite to each other, one on PZT layer and the other at the

back of the shaft. The parts of the harvester are shown in Fig. 1(a) in detail. The propeller is directed to the direction of wind flow via a Plexiglas tail. When the wind flows through the blades in the wind tunnel (see in Fig. 1(b)), the shaft rotates about the shaft axis and the permanent magnet attached to the end of the shaft is rotated. When the magnet gets closer to the magnet which is attached to the tip of the PZT layer, the layer is bent downwards without any mechanic contact, since the poles of the magnets are same. Every rotation creates a vibration and that is then converted to the electrical potential on the PZT layer. This wind energy harvester is a novel one with that respect, since there is no wind energy harvester including permanent magnet having contactless operation in the literature. This feature is very important for the durability of the PZT layers working continuously. Details of this device can be found in [22]–[24]. This harvester has one PZT layer which is located at the back of the shaft. The PZT has the sizes of 70 mm × 32 mm × 1.5 mm and the weight of 10 gr. In addition, its capacitance and stiffness values are 232 nF and 188 N/m, respectively. During the experiments, an effective data acquisition system (NI USB-6250 DAQ) is used. The data acquisition card has 16 analog inputs; thereby it is possible to get multiple records of different physical parameters such as displacement and output voltages, synchronously. Initially, the overall setup which was shown in Fig. 1(b) was tested in the wind tunnel. An anemometer measuring the wind speed of the tunnel was used as seen in Fig. 1(b).

After the preliminary tests in wind tunnel, we managed to reach the characteristic harvested power curve of the proposed harvester (Fig. 2). During the tests, a wide range of wind speeds was scanned from 2 m/s to 13 m/s.

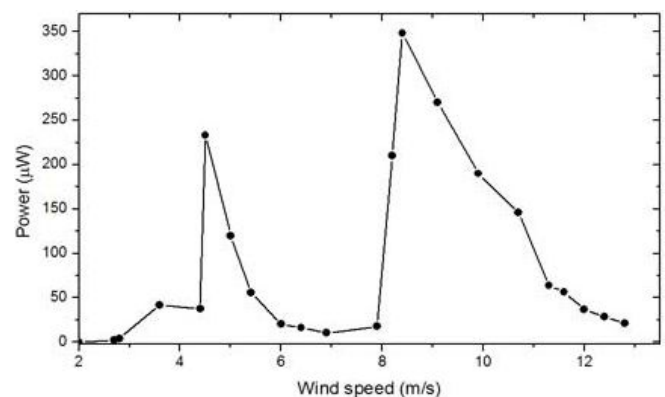

Fig. 2. Harvested power from harvester as function of wind speed.

According to the wind map of the region, these speed values indicate all possible conditions in order to harvest

energy. Figure 2 shows two independent peaks, where maximal power outputs are received. Note that the power shown in this figure has been measured across the terminals of the regulator circuit which was attached at the terminals of PZT. The specifications of the regulator circuit are given in Table I.

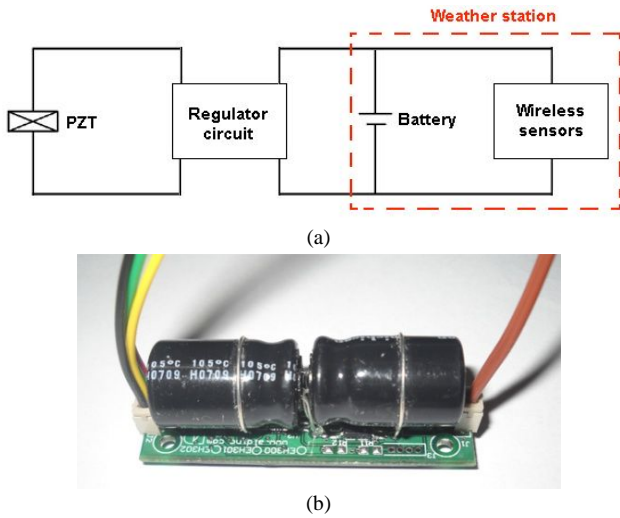

Fig. 3. Diagram of signal regulation from the output of PZT layer and connection to station (a); a commercial regulator [25] connected to the weather station after PZT (b).

TABLE I. SPECIFICATIONS OF ENERGY HARVESTER CIRCUIT [25].

Maximum instantaneous input voltage	± 500 V
Maximum instantaneous input current	400 mA
Maximum input power	500 mW
Min. charging input(Power dissipation)	6 V @ 500nA (3μW)
Internal voltage clamp	1 A
Useful average energy output	55 mJ
Output On-time rating	88 ms @ 150 mA

Figure 2 gives interesting character because of two separate peaks. To our knowledge, it is first time to prove such an effect in a wind energy harvester. The maximal generated power are obtained for  $v = 4.5$  m/s and  $v = 8.4$  m/s. Thus it is obvious that the harvester should operate at certain wind speeds for maximal power.

According to these maximal speeds, the system generates 233 μW and 348 μW. After  $v=8.4$  m/s, the generated power decreases for high wind speeds such as 10 m/s (Fig. 2). According to our previous paper [11], every PZT layer has a natural frequency  $f_0$ , where the maximal power is harvested. For instance in [11], it has been observed that an external periodic agnetic effect leads to maximal power, if it would be at the vicinity of the  $f_0$ . The frequency of mechanical vibration plays an important role to characterize the power at different system parameters in that context.

In this applicaton, wind speed exerts a certain angular velocity to the propeller and if the rotation frequency ( $f$ ) exceeds a certain value, the condition  $f > f_0$  occurs and the vibration of the PZT layer can not be completed since the magnets move away from each other before the natural excitation of the layer. With that respect, any PZT layer can be modelled as a pendulum with a natural frequency  $f_0$ . If the rotation frequency differs from  $f_0$ , the layer cannot come into the resonance, thus the harvested power decreases

dramatically. In our tests, the rotation frequency of propeller  $f = 23.08$  Hz is measured at  $v=8.4$  m/s. In addition, nearly subharmonic frequency of this rotation rate (i.e.  $f = 11.7$  Hz corresponding to 4.5 m/s) also produced a power peak having the power ratio 2/3 of the maximal power. Therefore one can obtain smoother power instead of some individual peaks by using multifrequency layers as we will proceed our future works on that issue.

Figure 3(a) shows the connections of the PZT to the regulator circuit and weather station. In order to avoid the voltage drops caused by the use of diodes in ordinary rectifying circuits, an effective commercial regulator circuit shown in Fig. 3(b) is used. It consists of a capacitor couple with ac-dc and dc-dc converters.

#### IV. INSTALLATION OF WIND ENERGY HARVESTER TO THE WEATHER STATION

The weather station which was fed by the harvester is Vantage Pro 2 Station (Fig. 4). This station has a number of capabilities such as the measurements of humidity, temperature, solar radiation density and wind speed.



Fig. 4. Installed wind energy harvester which feeds the weather station.

TABLE II. THE POWER SPECIFICATIONS OF WIRELESS WEATHER STATION.

Current Draw	0.14 mA (av.), 30 mA (peak)
Battery	3-Volt Lithium/2.4 Volt NiCad
Battery Life	8 months (3-Volt Lithium cell) 1 year (NiCad C-cells)

Table II presents the power specifications of weather station. As shown in Table II, the weather station draws 0.14 mA, when it is fed by 2.4 V batteries. In this case, an averaged power  $P = 336 \mu W$  is consumed in order to operate the station. Note also that the battery life of the station is 8 months.

#### V. POWER OBSERVATION OF INSTALLED SYSTEM

The power observation of the wind energy harvester is

carried out during one year in order to examine at which extent the harvesting power is available. Initially, we present the averaged wind speeds of the central region in Ankara, where the station and harvester are positioned (Fig. 5). While the region receives wind with nearly 10 m/s speed around March, this value decreases drastically down to 4 m/s–2 m/s in summer and winter time in the region.

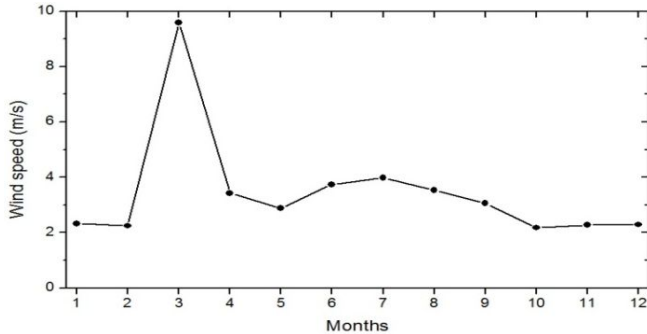

Fig. 5. Averaged wind speeds over one year in centre of Ankara.

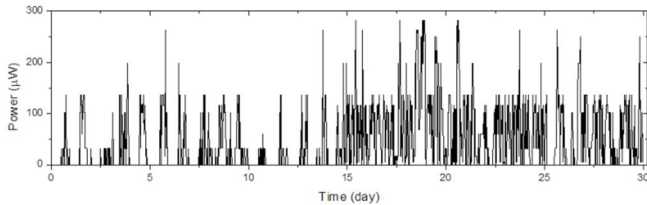

Fig. 6. Averaged harvested power during June 2012.

Figure 6 gives the generated power from the harvester during June 2012. While the beginning of June has relatively lower power contribution, at the end of the month, much power is obtained due to the climate conditions in the region. Note that although June is not a preferable month to get high wind speeds (according to Fig. 5), a power range of 20  $\mu\text{W}$ –280  $\mu\text{W}$  is obtained during this month. In fact, the harvester can provide much power in March. In order to give a better idea on how the harvester power changes in small time scales, we present Fig. 7. In 1h, the generated power from the wind energy harvester changes from 25  $\mu\text{W}$  to 125  $\mu\text{W}$  in general.

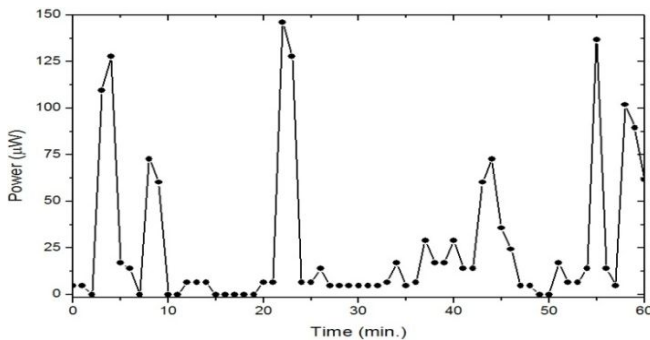

Fig. 7. Averaged power over minute on 9<sup>th</sup> Sep. 2012 between 14.00 h–15.00h.

During 2012, the averaged harvester power is given in Fig. 8. In fact the obtained power reflects the wind regime at the region. Furthermore, the averaged power for each month fluctuates between 15  $\mu\text{W}$  and 62  $\mu\text{W}$ . The axis at right-hand side determines the power contribution to the station when the consumed power by the station is considered.

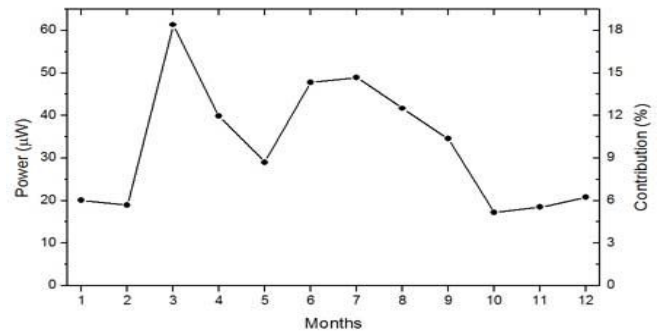

Fig. 8. Averaged harvested power for each month and the contribution to the consumed power of station in percentage.

According to these results, a contribution between 5 %–18 % is ascertained depending on the averaged wind speeds. The efficiency of the harvester system with mechanical and piezoelectric units is calculated as 0.0014 % and 0.048 % for high and low wind speeds, respectively. However, these values can be increased further after the addition of several PZT layers into the harvester.

## VI. CONCLUSIONS

A new contactless wind energy harvester using a piezoelectric layer is constructed and a feasibility study on the energy harvesting features has been carried out. The new harvester has permanent magnets, which push the PZT layer with permanent magnet end. The pole of the magnet is oriented in such a way that the end of harvester layer is always repelled. Therefore the magnetic force causes a mechanical buckling on the layer and this effect produces electricity between the terminals of the layer. The use of this magnetic effect increases the life span of the piezoelectric layer since any mechanical direct contact is not made on the layer. The harvester is implemented to a weather station and it is observed that it can contribute to the station power up to 18 % depending on the wind velocity. In addition, the new harvester can operate below the wind speeds of 3 m/s and produce energy for the station. In the future study, we consider to include several PZT layers to the harvester for the improvement of the efficiency.

## REFERENCES

- [1] S. P. Beeby, R. N. Torah, M. J. Tudor, P. Glynn-Jones, T. O'Donnell, C. R. Saha, S. Roy, "A micro electromagnetic generator for vibration energy harvesting", *J. Micromech. Microeng.*, vol. 17, pp. 1257–1265, 2007. [Online]. Available: <http://dx.doi.org/10.1088/0960-1317/17/7/007>
- [2] R. S. Sanders, M. T. Lee, "Implantable Pacemakers" in *Proc. IEEE*, 1996, vol. 84, pp. 480–486. [Online]. Available: <http://dx.doi.org/10.1109/5.486749>
- [3] Y. Uzun, E. Kurt, "Performance exploration of an energy harvester near the varying magnetic field of an operating induction motor", *Energy Convers. Manage.*, vol. 72, pp. 156–162, 2013. [Online]. Available: <http://dx.doi.org/10.1016/j.enconman.2012.10.023>
- [4] D. Vasic, C. Yu-Yin, F. Costa, "Self-powered piezoelectric energy harvester for bicycle", *39th Annual Conf. IEEE Industrial Electronics Society*, Vienna, 2013, pp. 1856–1861.
- [5] J. G. Rocha, L. M. Goncalves, P. F. Rocha, M. P. Silva, S. Lanceros-Mendez, "Energy harvesting from piezoelectric materials fully integrated in footwear", *IEEE Trans. Industrial Electronics*, vol. 57, no. 3, pp. 813–819, 2010. [Online]. Available: <http://dx.doi.org/10.1109/TIE.2009.2028360>
- [6] P. Pillatsch, E. M. Yeatman, A. S. Holmes, "A piezoelectric

- frequency up-converting energy harvester with rotating proof mass for human body applications”, *Sensors and Actuators A*, vol. 206, pp. 178–185, 2014. [Online]. Available: <http://dx.doi.org/10.1016/j.sna.2013.10.003>
- [7] A. K. Widiawan, R. Tafazolli, “High altitude platform station (HAPS): A review of new infrastructure development for future wireless communications”, *Wireless Personal Communications*, vol. 42, pp. 387–404, 2007. [Online]. Available: <http://dx.doi.org/10.1007/s11277-006-9184-9>
- [8] A. Mainwaring, D. Culler, J. Polastre, R. Szewczyk, J. Anderson, “Wireless sensor networks for habitat monitoring”, *1st ACM Int. Workshop on Wireless Sensor Networks and Applications*, Atlanta, 2002, pp. 88–97. [Online]. Available: <http://dx.doi.org/10.1145/570738.570751>
- [9] N. Sharma, J. Gummeson, D. Irwin, P. Shenoy, “Cloudy computing: leveraging weather forecasts in energy harvesting sensor systems”, *7th Annual IEEE Comm. Society Conf. on Sensor Mesh and Ad Hoc Comm. And Networks*, Massachusetts, 2010, pp. 1–9.
- [10] S. Peng, C.P. Low, “Prediction free energy neutral power management for energy harvesting wireless sensor nodes”, *Ad Hoc Networks*, vol.13, pp. 351–367, 2014. [Online]. Available: <http://dx.doi.org/10.1016/j.adhoc.2013.08.015>
- [11] Y. Uzun, E. Kurt, “Implementation and modeling of a piezoelectric pendulum under a harmonic magnetic excitation”, in *11. Int. Conf. Applications of Electrical Engineering*, Athens, 2012, pp. 184–189.
- [12] O. Zorlu, H. Kulah, “A MEMS-based energy harvester for generating energy from non-resonant environmental vibrations”, *Sensors and Actuators A*, vol. 202, pp. 124–134, 2013. [Online]. Available: <http://dx.doi.org/10.1016/j.sna.2013.01.032>
- [13] S. Roundy, E. Takahashi, “A planar electromagnetic energy harvesting transducer using a multi-pole magnetic plate”, *Sensors and Actuators A*, vol. 195, pp. 98–104, 2013. [Online]. Available: <http://dx.doi.org/10.1016/j.sna.2013.03.018>
- [14] Y. Uzun, E. Kurt, “The effect of periodic magnetic force on a piezoelectric energy harvester”, *Sensors and Actuators A*, vol. 192, pp. 58–68, 2013. [Online]. Available: <http://dx.doi.org/10.1016/j.sna.2012.12.017>
- [15] D. A. Wang, H. H. Ko, “Piezoelectric energy harvesting from flow-induced vibration”, *J. Micromech. Microeng.*, vol. 20, p. 025019, 2010. [Online]. Available: <http://dx.doi.org/10.1088/0960-1317/20/2/025019>
- [16] Y. Rao, S. Cheng, D. P. Arnold, “An energy harvesting system for passively generating power from human activities”, *J. Micromech. Microeng.*, vol. 23, p. 114012, 2013. [Online]. Available: <http://dx.doi.org/10.1088/0960-1317/23/11/114012>
- [17] E. K. Reilly, F. Burghardt, R. Fain, P. Wright, “Powering a wireless sensor node with a vibration-driven piezoelectric energy harvester”, *Smart Mater. Struct.*, vol. 20, p. 125006, 2011. [Online]. Available: <http://dx.doi.org/10.1088/0964-1726/20/12/125006>
- [18] E. Minazara, D. Vasic, F. Costa, G. Poulin, “Piezoelectric diaphragm for vibration energy harvesting”, *Ultrasonics*, vol. 44, pp. 699–703, 2006. [Online]. Available: <http://dx.doi.org/10.1016/j.ultras.2006.05.141>
- [19] W. G. Li, S. He, S. Yu, “Improving power density of a cantilever piezoelectric power harvester through a curved L-shaped proof mass”, *IEEE Trans. on Industrial Electronics*, vol. 57, 2010.
- [20] M. Lallart, S. Priya, S. Bressers, D. J. Inman, “Small-scale piezoelectric energy harvesting devices using low-energy-density sources”, *Journal of the Korean Physical Society*, vol. 57, pp. 947–951, 2010. [Online]. Available: <http://dx.doi.org/10.3938/jkps.57.947>
- [21] R. Myers, M. Vickers, H. Kim, “Small scale windmill”, *Applied Physics Letters*, vol. 90, p. 054106, 2007. [Online]. Available: <http://dx.doi.org/10.1063/1.2435346>
- [22] Y. Uzun, M. Demirtas, E. Kurt, “Exploration of the energy harvesting for a weather station”, in *2nd European Workshop on Renewable Energy Systems*, Antalya, 2012.
- [23] Qingshan Xu, HaixiangZang, “Development of TMY database in Northeast China for Solar Energy Applications”, *Elektronika ir Elektrotechnika*, no. 7, pp. 103–108, 2012. [Online]. Available: <http://dx.doi.org/10.5755/j01.eee.123.7.2386>
- [24] S. Kaseta, V. Grimaila, D. Rukavicius, “Experimental Research of Signal Fading in Fixed Wireless Links”, *Elektronika ir Elektrotechnika*, vol. 20, no. 4, pp. 72–75, 2014. [Online]. Available: <http://dx.doi.org/10.5755/j01.ee.20.4.2921>
- [25] EH301A datasheet, *Advanced Linear Devices Inc.*, USA, 2012, pp. 1–4. [Online] Available: <http://www.aldinc.com/pdf/EH300.pdf>