

Tooth Canal Working Length Electric Meter

Eduardas Kelbauskas¹, Robertas Lukocius², Povilas Marciulionis², Jonas Martynaitis⁴,
Konstantinas Otas², Aleksandr Rybakov¹, Renaldas Urniezius³, Juozapas Arvydas Virbalis²

¹Lithuanian University of Health Sciences,
Eiveniu g. 2, LT-50009 Kaunas, Lithuania

²Department of Electrical Power Systems, Faculty of Electrical and Electronics Engineering,
Kaunas University of Technology,
Studentu St. 48, LT-51367 Kaunas, Lithuania

³Department of Automation, Faculty of Electrical and Electronics Engineering,
Kaunas University of Technology,
Studentu St. 48, LT-51367 Kaunas, Lithuania

⁴UAB LUMEN,
Partizanu St. 210-87 LT-50321, Kaunas, Lithuania
arvydas.virbalis@ktu.lt

Abstract—Electrical apical constriction locators are not harmful for humans and allow to measure exactly the physiological apex of tooth root canal. The original apex locator measurement circuit is presented. It has the power supply sources of low and high frequencies. Each measurement cycle consists of three measurement intervals. The dependence of measurement accuracy on capacitance between the electrodes and other canal electric properties is eliminated. The analysis of measurement circuit is performed. The results of experimental investigation are presented. The apical constriction is found reliably and exactly.

Index Terms—Apical constriction, electric resistance, measurement.

I. INTRODUCTION

One of more frequently performed endodontic procedures is processing of tooth root canal. The root canal ends with apical constriction (Fig. 1). It is very important that endodontic instrument could not pass beyond the apical constriction (anatomical apex) and could not break soft tissues of the patient. Therefore the position of apical constriction must be found exactly. In endodontology the measurement of apical constriction position is called tooth root canal working length measurement.

Initially, radiographs for canal working length were used. Later alternative measurement instruments –Apex locators – were developed. In Apex locators the electric resistance between two electrodes is measured. The possible arrangement of Apex locator electrodes is shown in Fig. 1(d) is distance to apical constriction tip – physiological apex (P). A is anatomical apex. One electrode (E2) is placed on the patient's lip or is kept in hand while the other electrode (E1) which can be superposed with endodontic instrument is inserted in canal.

Using Apex locators for tooth root working length

measurement allows decreasing the quantity of radiographs and patients are not affected by harmful X-rays. Apex locators have been used for more than 40 years [1]–[4], but diversity of human teeth and anatomy requires permanent development of these devices to guarantee reliable measurement regardless patient age, canal geometry, used medication, etc. Original Apex locator has been developed in Lithuania. It is protected by UK patent [5]. It was improved additionally to increase its accuracy and reliability. The improved Apex locator is presented in this paper.

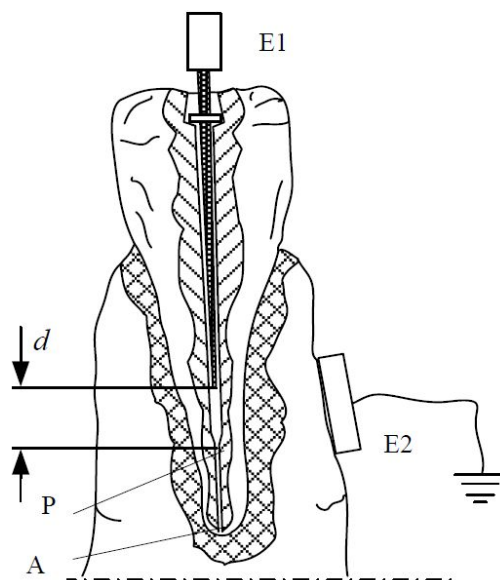

Fig. 1. The arrangement of Apex locator electrodes.

II. THE ELECTRIC CIRCUIT OF BODY BETWEEN ELECTRODES

The electric properties of the human body tissue between electrodes can be presented by electric circuit shown in Fig. 2. Different electric signals of biological nature act in human body. Galvanic internal voltage is generated in the junction of two materials with different electrochemical potentials. There are several junctions in the body part

Manuscript received December 10, 2013; accepted October 26, 2014.

This research was funded by a grant (No. 31V-41/13) from the Science, Innovations and Technology Agency of Lithuania (MITA). This research was performed in cooperation with the Institution.

between electrodes: electrode – mucosa, electrode – moisturizing fluid, soft tissues – moisturizing fluid. In Fig. 2 voltages of these junctions as equivalent voltage source $e_n(t)$ are presented. The voltage of this source can be presented as direct voltage corrupted by low frequency noises. The main part of these noises is concentrated in the range of 0 Hz–100 Hz. The capacitance C_s presents the phenomenon of electric charge accumulation in the junctions of materials with different electrochemical potentials. R_s is resistance of soft tissues between electrode E2 and tooth canal junction with soft tissues, R_p and C_p are correspondingly, the resistance and capacitance between electrode E1 and above-mentioned junction. When the distance d between the E1 and apical constriction varies (see Fig. 1), R_p varies, too. For R_p measurement the stable voltage source must be connected to electrodes E1 and E2. To suppress the influence of voltage $e_n(t)$ on measurement result it is sufficient to use the sinusoidal voltage u_{i0} with frequency $f > 100$ Hz and narrow band filter.

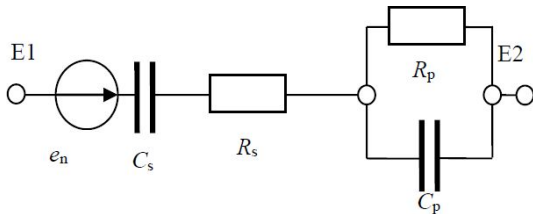

Fig. 2. Equivalent electric circuit of body between electrodes.

The resistance R_p depends on electric conductance of liquids used for canal processing and may vary by the order of six. The capacitance C_p also depends on the liquid type too. Theoretical and experimental investigations [1]–[4] show, that for accurate resistance R_p measurement two voltage sources of different frequency are needed. One of these sources benefits to form the signal which compensates the resistance variation because the canal processing conditions variation. But realization of such compensation can be different.

III. BLOCK DIAGRAM OF MEASUREMENT

The electric circuit of measurement canal of Apex locator [5] is presented in Fig. 3. Here u_{i0} and u_{h0} are sources of low and high frequency sinusoidal voltages, R_0 – constant resistor, $Z_x = Z_x(\omega, R_s, C_s, R_p, C_p)$ complex (phasor) impedance between electrodes, D1 – resistor divider with controlling division coefficient, composed of resistors R_{v1} , R_{v2} , D2 – resistor divider with constant division coefficient, composed of resistors R_{k1} , R_{k2} , K1 and K2 – three-pole switches. Frequency of the source u_{i0} is greater than 100 Hz, frequency of the source u_{h0} is at least ten times greater than the frequency of the source u_{i0} . Therefore the influence of parasitic source e_p (Fig. 2) on measurement signal is insignificant. The impedance Z_x has capacitive character. It is presented in Fig. 3 by parallel $R_x C_x$ circuit. R_x and C_x may be expressed by the elements of equivalent circuit Fig. 2 and angular frequency ω as follows:

$$R_x = R_s + \frac{R_p}{1 + \omega^2 C_p^2 R_p^2}, \quad (1)$$

$$C_x = C_s \frac{1 + \omega^2 C_p^2 R_p^2}{1 + \omega^2 C_p^2 R_p^2 + \omega^2 C_p C_s R_p^2}. \quad (2)$$

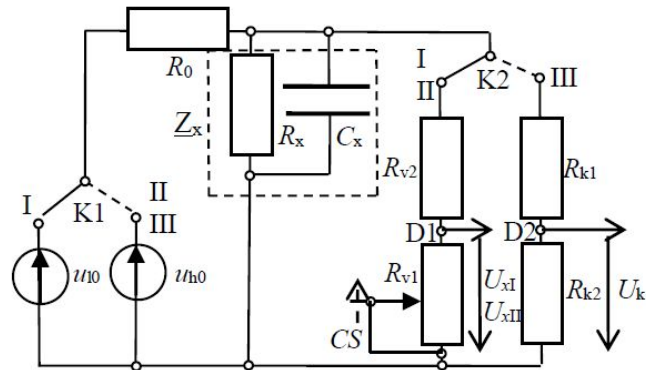

Fig. 3. Electric circuit of measurement cycles.

Measurement consists of three cycles. In the first cycle the switches K1 and K2 are in the position I. Measurement circuit input is connected to low frequency source u_{i0} , circuit output is connected to divider D1 (resistors R_{v1} , R_{v2}). The output voltage U_x of divider D1 is connected to input of narrow band amplifier – detector SSD1 which is part of control circuit (see Fig. 4). In SSD1 signal U_x is filtered, K times amplified and rectified. In comparator CM rectified signal $U_1 = KU_{x1}$ is compared with reference voltage U_r . In the output unit OU control signal CS (output signal of control circuit CC) is formed. This signal is fed to control input of divider D1 part R_{v1} (typically, field transistor,) where it changes its resistance and divider output voltage U_x . Divider D1, amplifier – detector SSD1, comparator CM and output unit OU contain the circuit of negative feedback. This circuit changes U_x such that error signal $UU = KU_{x1} - U_r$ which is input signal of comparator CM could be infinitely small. This way the effective value \underline{U}_{x1} of phasor \underline{U}_{x1} is set in the first cycle as follows

$$\underline{U}_{x1} = U_r / K. \quad (3)$$

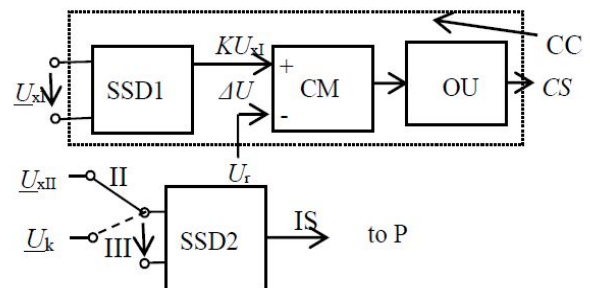

Fig. 4. The control circuit CC and information signal IS formation.

In second measurement cycle switch K1 is commutated into position II. The high frequency source u_{h0} is connected to measurement circuit. The divider's D1 division coefficient remains unchanged. The output voltage phasor of D1 is \underline{U}_{xII} .

In the third cycle the source u_{h0} remains connected to measurement circuit, but measurement circuit output is connected to divider D2 with output signal phasor \underline{U}_k . Signals \underline{U}_{xII} and \underline{U}_k are fed into processor P via narrow band amplifier-detector SSD2 (Fig. 4).

IV. ANALYSIS OF MEASUREMENT CIRCUIT

Voltage in measurement circuit is formed by sources of sinusoidal voltage of low frequency $u_{l0} = U_{ml0}\sin\tilde{S}_l t$ and high frequency $u_{h0} = U_{mh0}\sin\tilde{S}_h t$. Suppose that non-equalities $Z_{xh} \ll R_{v1} + R_{v2}$, $Z_{xh} \ll R_{k1} + R_{k2}$ and $Z_{xl} \ll R_{v1} + R_{v2}$ are valid. Here Z_{xh} and Z_{xl} are the moduli of complex (phasor) impedances \underline{Z}_{xh} and \underline{Z}_{xl} for high and low frequency, correspondingly. Let represent the voltages u_{l0} and u_{h0} by phasors \underline{U}_{l0} and \underline{U}_{h0} , correspondingly. The current phasors \underline{I}_h and \underline{I}_l for high and low frequency, correspondingly, are:

$$\underline{I}_h = \frac{\underline{U}_{h0}}{R_0 + \underline{Z}_{mh}}, \quad (4)$$

$$\underline{I}_l = \frac{\underline{U}_{l0}}{R_0 + \underline{Z}_{ml}}. \quad (5)$$

The phasors of divider output voltages \underline{U}_{xh} and \underline{U}_{xl} for high and low frequency, correspondingly, may be written:

$$\underline{U}_{xh} = \underline{I}_h \times \underline{Z}_{xh} \times \frac{R_{v1}}{R_{v2} + R_{v1}} = \frac{\underline{U}_{h0} \times \underline{Z}_{xh}}{R_0 + \underline{Z}_{xh}} \times \frac{R_{v1}}{R_{v2} + R_{v1}}, \quad (6)$$

$$\underline{U}_{xl} = \underline{I}_l \times \underline{Z}_{xl} \times \frac{R_{v1}}{R_{v2} + R_{v1}} = \frac{\underline{U}_{l0} \times \underline{Z}_{xl}}{R_0 + \underline{Z}_{xl}} \times \frac{R_{v1}}{R_{v2} + R_{v1}}. \quad (7)$$

Division coefficient of divider D1 by (3) and (7) is

$$\frac{R_v}{R_v + R_{in}} = \frac{U_r \times (R_0 + \underline{Z}_{xl})}{K \times \underline{U}_{l0} \times \underline{Z}_{xl}}. \quad (8)$$

Substituting this expression into (6) produces

$$\underline{U}_{xh} = \frac{U_r}{K} \times \frac{\underline{U}_{h0}}{\underline{U}_{l0}} \times \frac{\underline{Z}_{xh}}{\underline{Z}_{xl}} \times \frac{R_0 + \underline{Z}_{xl}}{R_0 + \underline{Z}_{xh}}. \quad (9)$$

Taking into account that R_x and C_x are connected in parallel the following may be expressed:

$$\frac{\underline{Z}_{xh}}{R_0 + \underline{Z}_{xh}} = \frac{1}{1 + R_0/R_{xh} + j\tilde{S}_h C_{xh} R_0}, \quad (10)$$

$$\frac{\underline{Z}_{xl}}{R_0 + \underline{Z}_{xl}} = \frac{1}{1 + R_0/R_{xl} + j\tilde{S}_l C_{xl} R_0}, \quad (11)$$

where R_{xh} and C_{xh} are expressed by (1) and (2), when $\tilde{S} = \tilde{S}_h$, R_{xl} and C_{xl} are expressed by (1) and (2), when $\tilde{S} = \tilde{S}_l$. Substituting (10) and (11) into (9) the following may be written

$$\underline{U}_{xh} = \frac{U_r}{K} \times \frac{\underline{U}_{h0}}{\underline{U}_{l0}} \times \frac{1 + R_0/R_{xl} + j\tilde{S}_l C_{xl} R_0}{1 + R_0/R_{xh} + j\tilde{S}_h C_{xh} R_0}. \quad (12)$$

Modulus U_{xh} of phasor \underline{U}_{xh} is

$$U_{xh} = \frac{U_r}{K} \times \frac{U_{h0}}{U_{l0}} \times \frac{\sqrt{(1 + R_0/R_{xl})^2 + \tilde{S}_l^2 C_{xl}^2 R_0^2}}{\sqrt{(1 + R_0/R_{xh})^2 + \tilde{S}_h^2 C_{xh}^2 R_0^2}}, \quad (13)$$

where U_{h0} and U_{l0} are effective values of voltages u_{h0} and u_{l0} , correspondingly. The frequencies must be chosen such that the following non-equalities could be valid:

$$(1 + R_0/R_{xl})^2 \gg \tilde{S}_l^2 C_{xl}^2 R_0^2, \quad (14)$$

$$(1 + R_0/R_{xh})^2 \ll \tilde{S}_h^2 C_{xh}^2 R_0^2, \quad (15)$$

$$\begin{cases} R_0/R_{xl} \gg 1, \\ R_0/R_{xh} \gg 1. \end{cases} \quad (16)$$

The (13) expression may be simplified as follows

$$U_{xh} \approx \frac{U_r}{K} \times \frac{U_{h0}}{U_{l0}} \times \frac{1}{\tilde{S}_h C_{xh} R_0}. \quad (17)$$

In third cycle the measurement circuit output signal phasor \underline{U}_k can be expressed by (6), substituting $R_{k1}/(R_{k1} + R_{k2})$ instead of $R_{v1}/(R_{v1} + R_{v2})$. Taking into account (10), (15) and (16) \underline{U}_k effective value U_k can be expressed as

$$U_k \approx \frac{R_{k1}}{R_{k1} + R_{k2}} \times \frac{U_{h0}}{\tilde{S}_h C_{xh} R_0}. \quad (18)$$

We obtain measurement signal N_x by dividing U_k by U_{xh}

$$N_x = \frac{U_k}{U_{xh}} \approx \frac{K \cdot R_{k1}}{R_{k1} + R_{k2}} \times \frac{U_r}{U_{l0}} \times \frac{1}{R_0} \times R_{xl} = A R_{xl}, \quad (19)$$

where $A = (K/R_0) \times (R_{k1}/(R_{k1} + R_{k2})) \times (U_r/U_{l0}) = const.$

Expression (19) is independent on C_x if it does not change during the second and third measurement cycles.

Taking into account (14) and (16) from (1) it follows that $R_{xl} = R_s + R_p$. When working instrument coupled with electrode E1 (see Fig.1) approaches the apical constriction, $R_p \rightarrow 0$ and $R_{xl} \rightarrow R_s$. Setting R_s during Apex locator calibration apical constriction point may be determined exactly.

V. TECHNIQUE OF EXPERIMENTAL INVESTIGATION

The experimental investigation was performed *in vitro*. The block diagram of investigation is shown in Fig. 5.

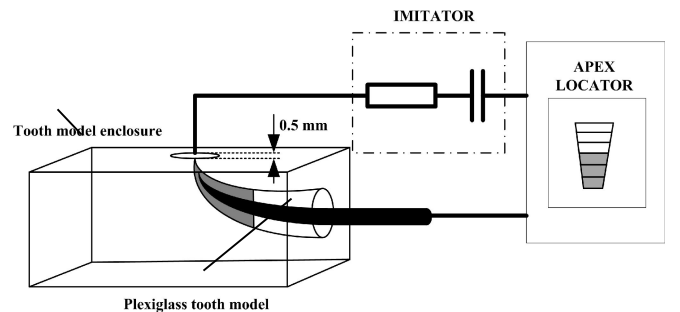

Fig. 5. The block diagram of experimental investigation.

The working length of tooth root canal was measured in canals of four different sizes with endodontic instruments of four different diameters and using six different solutions for canal filling.

A plexiglas model of the tooth was used that had the

cavity of the same shape as the tooth root canal. The apex in the model was formed by a segment of wire inserted into cavity 0,5 mm short of its end. The conditions of the oral mucosa were simulated using imitator – RC circuit. One simulator output was connected to the wire segment that imitated the tooth root tip, the other output was connected to the passive electrode of the apex locator E2. Different Protaper endodontic instruments were used. They are shown in Fig. 6. The maximal diameters of instruments are F1 – 0,2 mm, F2 – 0,25 mm, F3 – 0,3 mm and F4 – 0,4 mm.



Fig. 6. Used endodontic instruments connected to electrode E1.

At first canals in the Plexiglas tooth models were formed by different Protaper instruments. These models were numbered analogically as instruments: F1 (maximal diameter $d_{\max} = 0,2$ mm), F2 ($d_{\max} = 0,25$ mm), F3 ($d_{\max} = 0,3$ mm) and F4 ($d_{\max} = 0,4$ mm).

The following liquids were used to fill canals in the experimental investigation: distilled water (specific electric conductance $= 5 \cdot 10^{-6}$ S/m, 0,5 % solution of NaOCl ($= 2,6$ S/m), 3 % solution of hydrogen peroxide H_2O_2 ($= 10^{-4}$ S/m), blood ($= 0,6$ S/m), saliva ($= 1$ S/m), and ubistesin ($= 1,5$ S/m), which is used for anaesthesia. The models with different cavity diameters, instruments and liquids used in experimental investigation cover the variety of real tooth canals and tools using for it processing.

The investigated tooth model was connected into the circuit shown in Fig. 5. At first, the experiment was performed with the instrument that had the same number as the imitator. Next, instruments with smaller numbers were used. To measure the real working length instrument was inserted into dry canal to contact with wire segment that imitated the tip. The length of inserted instrument part was measured by electronic calliper. When the real working length was measured, the testing solutions were one by one injected into tooth imitator cavity and the working length was measured using Apex locator. For chosen instrument and chosen solution the measurements were repeated 50 times.

VI. EXPERIMENT RESULTS AND DISCUSSION

The main aim of Apex locator is to indicate reliably that endodontic instrument *approaches* the apical constriction. If it indicates this point after the moment when the instrument touches the apical constriction can be too late due to moving inertia (overinstrumentation). It is important, that Apex locator should operate when distance d of instrument tip to apical constriction (physiological apex) is approximately 0 ÷ 2 mm.

The number of 1500 measurements was performed and in all cases apex locator was fixed such that apical constriction is reached though working instrument without touching the tip imitating wire. The distance d was in interval $[0,08 \div 1,92]$ mm for all 1500 cases. Therefore, it may be claimed that the investigated Apex locator functioned very reliably.

The summary of results obtained in canal of 0,4 mm using different instruments is presented in Table I. It can be seen that using solutions of smaller conductivity the distance to the apical constriction was measured more precisely. But difference among results is not big considering difference among the conductances. For example, conductance of NaOCl is 10^6 times greater than conductance of distilled water.

TABLE I. THE MEAN DISTANCE OF APEX LOCATOR ACTION POINT AT APICAL CONSTRICTION AND ITS DEVIATION.

Endodontic instrument	F1	F2	F3	F4
Dist. H ₂ O	0,61±0,24	0,23±0,11	0,22±0,14	0,32±0,15
H ₂ O ₂ 3%	0,38±0,28	0,27±0,11	0,24±0,11	0,28±0,08
Blood	0,81±0,18	0,56±0,04	0,72±0,16	0,67±0,07
Saliva	0,40±0,13	0,24±0,07	0,38±0,08	0,49±0,10
Ubistesin	1,70±0,22	1,51±0,15	1,15±0,16	1,14±0,12
NaOCl0,5%	1,36±0,20	1,10±0,12	0,95±0,10	1,42±0,09

Significantly greater scattering of results using instrument F1 with minimal diameter can be explained by the fact that the tip of this instrument may be in different positions in canal with respect to tooth root tip. But in all cases deviation from the mean value was not greater than $\pm 0,3$ mm.

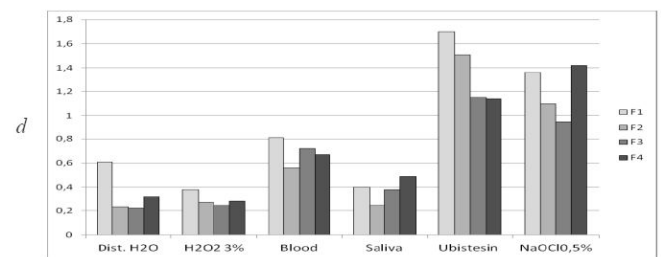

Fig. 7. The mean distance d of apex locator action point to apical constriction using instruments F1 – F4 and different solutions for 0,4 mm canal.

Distribution of mean distances at apical constriction for 0,4 mm canal and different instruments is shown in Fig. 7. Similar distribution is for 0,3 mm canal (see Fig. 8). The results for canals 0,2 mm and 0,1 mm are closed to results presented in Fig. 8.

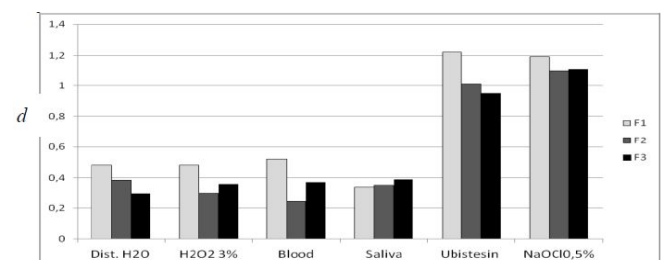

Fig. 8. The mean distance d of Apex locator action point to apical constriction using instruments F1 – F3 and different solutions for 0,3 mm canal.

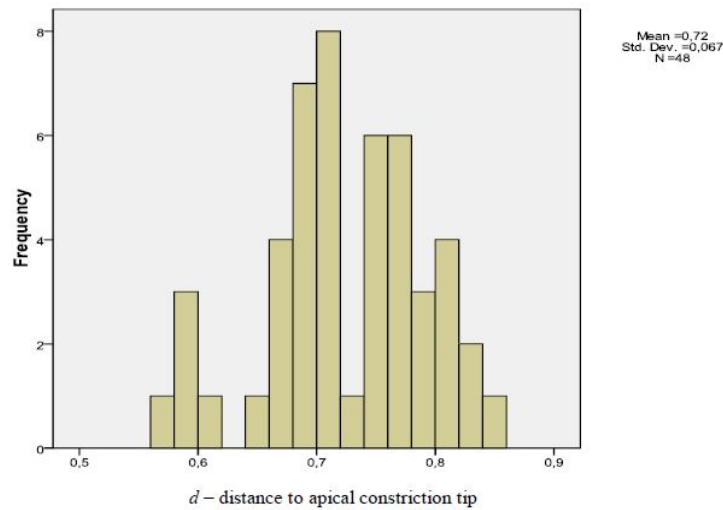

Fig. 9. Distribution of 48 results, canal 0,4 mm, instrument F3 (0,3 mm), blood, working length 16,0 mm.

Typical distribution of 48 measurement results obtained with the same instrument in the same liquid is presented in Fig. 9.

Figure 9 shows that the measurement result distribution law is very close to normal.

VII. CONCLUSIONS

1. Measurement accuracy dependence not only on canal electrical properties, but on capacitance between the electrodes as well may be eliminated by using three different measurement intervals and power supply sources of low and high frequencies.
2. Experimental investigation in vitro showed that Apex locator with three measurement intervals allows reliably and exactly to find apical constriction point using instruments of different diameter and solutions which electric conductance that may vary in a wide range.

REFERENCES

- [1] L. Smadi, "Comparison between two methods of working length determination and its effect on radiographic extent of root canal filling: a clinical study", *BMC Oral Health*, vol. 6, p. 4, 2006.
- [2] Col MC Sharma, Maj Gen, V Arora, "Determination of working length of root canal", *Medical Journal Armed Forces India*, vol. 66, no. 3, pp. 231–234, 2010. [Online]. Available: [http://dx.doi.org/10.1016/S0377-1237\(10\)80044-9](http://dx.doi.org/10.1016/S0377-1237(10)80044-9)
- [3] D. G. Real, H. Davidowicz, C. Moura-Netto, C. L. Zenkner, C. M.L. Pagliarin, F. B. Barletta, A. A. M. de Moura, "Accuracy of working length determination using 3 electronic apex locators and direct digital radiography", *Oral Surg Oral Med Oral Pathol Oral Radiol Endod*, vol. 111, pp. 44–49, 2011. [Online]. Available: <http://dx.doi.org/10.1016/j.tripleo.2010.10.033>
- [4] N. Meridith, K. Gulabivala, "Electric impedance measurements of root canal length", *Endod Dent Traumatol*, vol. 13, pp. 126–131, 1997. [Online]. Available: <http://dx.doi.org/10.1111/j.1600-9657.1997.tb00025.x>
- [5] J. Martynaitis, R. Masiulis, "Apical constriction locator", Cl A61C 19/04. UK Patent, GB 2431 358.