

## Motion Analysis and Remote Control System using Pyroelectric Infrared Sensors

**R. Fuksis, M. Greitans, E. Hermanis**

*Institute of Electronics and Computer Science,  
 14 Dzerbenes Str., LV-1006, Riga, Latvia, phone: +371 67558203; e-mail: rihardsf@edi.lv*

### Introduction

All matter with a temperature above absolute zero emits infrared energy [1]. A typical structure of infrared radiation emitting and detection system includes an infrared source, transmission media, an optical lens or mirror to focus radiation, sensor and signal processing device.

Sources of infrared radiation include a whole spectrum of objects – sunlight, open fires, engines, heating pads, electronic equipment, living beings etc. [2]. The intensity of radiation emitted by a blackbody depends on the temperature and wavelength of the radiation as given by Planck's law [1-2].

$$L_{\lambda}(\lambda) = \frac{2hc^2}{\lambda^5} \left[ \exp \frac{hc}{\lambda kT} - 1 \right]^{-1}, \quad (1)$$

where  $\lambda$  is wavelength,  $T$  – temperature,  $c$  – speed of light,  $h$  – Planck's constant and  $k$  – Boltzmann's constant. The hotter the substance, the more radiation it emits and the shorter the average wavelength of the radiation emitted.

The research described in this paper is based on the idea of using the human body as a source and transmitter of information to the environmental atmosphere.

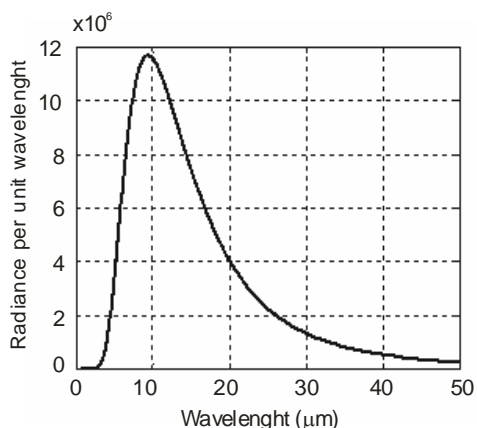

**Fig. 1.** Black-body radiation curve at 37 °C

Human bodies are quite good infrared sources due to their almost constant temperature. The spectral distribution of blackbody radiation at 37 °C (310 K) is illustrated by the curve in Fig. 1. It can be seen that all the radiation is in the infrared region with the peak wavelength close to 10 μm. To estimate radiation of heat of the human body to the environment, Stefan-Boltzmann's Law can be used [3]. The average human radiates about 100W/m<sup>2</sup> of power [4].

Infrared sensors that are sensitive in the range 7 – 15 μm could be used to detect a human. Such a quality is provided by sensors of two types: thermal and quantum. Quantum sensors offer high detection performance and a fast response speed, although their photo sensitivity is dependent on wavelength. In general, quantum detectors must be cooled for accurate measurement, except for detectors used in the near infrared region. By contrast, thermal sensors use the infrared energy as heat and their photo sensitivity is independent of wavelength [5]. Thermal sensors do not require cooling, but have a slower response time and detection capability. Several types of thermal detectors are known that are based on different principles of heat sensing – thermocouple, bolometer, pneumatic cell and pyroelectric element. In the next sections we will discuss signal detection and processing capabilities using a pyroelectric infrared (PIR) element as an infrared thermal sensor [6, 7].

### Signal acquisition and motion analysis using PIR sensors

There are several types of PIR sensors which vary in pyroelectric material and the number of pyroelectric elements. The pyroelectric detector consists of a lead zirconate titanate (PZT), which is spontaneously polarized in the dark state. When radiation is absorbed, the element temperature increases, resulting in a change in the polarization state, that is outputted as a voltage change. Since the detector senses only temperature changes, the single element PIR sensor is typically combined with a chopper for the measurement of still objects.

The dual element PIR sensor consists of a ceramic material that develops a voltage difference across its two elements due to the pyroelectric effect, a high resistance resistor  $R_g$  and a low-noise field effect transistor (FET),

hermetically sealed in a metal package to protect against external noise [5]. The equivalent circuit for dual element PIR sensor is shown in Fig. 2.

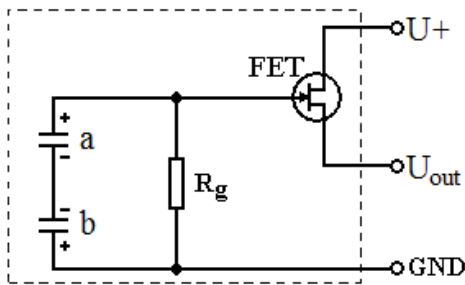

**Fig. 2.** Dual element PIR sensor equivalent circuit

Two series-connected pyroelectric elements (“a” and “b” in Fig. 2.) having opposite polarities compensate charges generated by background temperature variations such as by sunlight, external disturbance light or by vibration, and thus prevent the incorrect detection of a moving object. The sensor itself does not have wavelength dependence, but the combination of various window materials makes it usable for various applications, such as human body detection. There are also PIR sensors with quad elements, which are used in high-end security applications to detect the human body more precisely.

Fig. 3. illustrates the radiation acquisition system, which is based on a two element PIR sensor. In this system a Fresnel lens is used to focus infrared radiation. Each zone formed by the Fresnel lens refers to the appropriate sensor element. In order to produce signal output, sensor elements must sense heat difference. Let us discuss the reaction of sensor elements if the object is moving through both sensor elements. There are two main signals that can be generated by a PIR sensor depending on the element which is heated first. If object is moving from left to right the sensor output signal corresponds to “A” curve shown in Fig. 4., while if the object is moving from right to left the sensor output signal will be like B curve in Fig. 4. That allows a distinction to be made between two different scenarios, and can be employed for the transmission of commands.

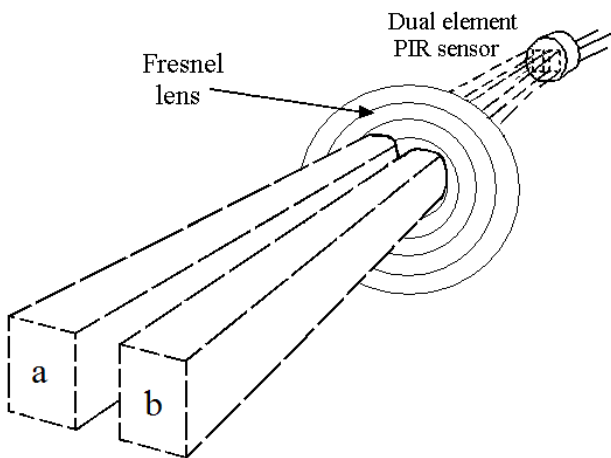

**Fig. 3.** Fields of view formed by a single segment Fresnel lens. Two separated areas correspond to each of the elements in dual element sensor

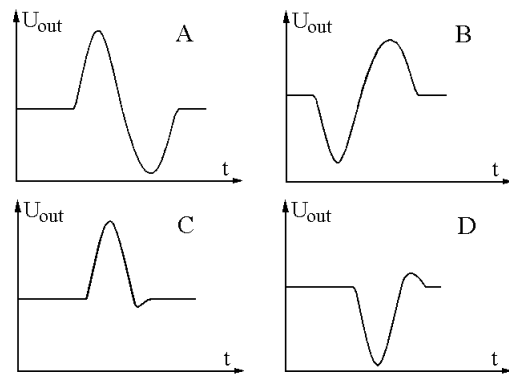
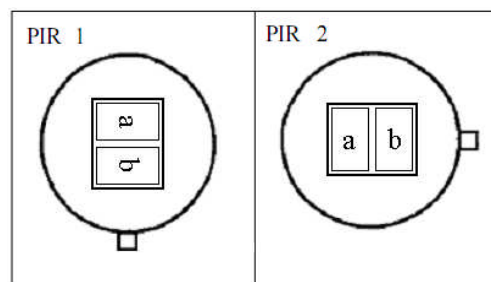

**Fig. 4.** Sensor reaction to human hand movement: A – through both sensor elements from left to right; B – through both sensor elements from right to left; C – only through left sensor element; D – only through right sensor element.

The heating of one of the sensor elements produces the output signal, which looks like a single peak. In this case the object has to be moved from right to left and stopped in position between both beams, thereby making the temperature change only in one sensor element. Depending on the element and direction the signal output will be like curve C or D in Fig.4. In such a way, it is possible to double the number of different commands that can be transmitted by hand movement and recognized using a dual element PIR sensor.

### Proposed approach for remote control system

The previous section discussed the detection and the analysis of movement using one dual element PIR sensor. The possibility of detecting the direction of a human or his hand motion was shown. Using one sensor the analysis can be done only in one dimension, because of the two main signal outputs. To extend this approach for analysis of two-dimensional motion, the use of two dual element PIR sensors is proposed, which are placed together and rotated by 90° one from another (see Fig.5.).



**Fig. 5.** 2 PIR sensors rotated by 90° to form a horizontal and vertical path identification system

Each of the sensors has its own Fresnel lens and can detect horizontal or vertical direction. If both are used together, the possibility arises of separating diagonal directions as well. Diagonal direction can be identified if both sensor outputs are analyzed simultaneously. Using the two PIR sensor system, a human infrared energy controlled remote control system with 8 possible commands can be established.

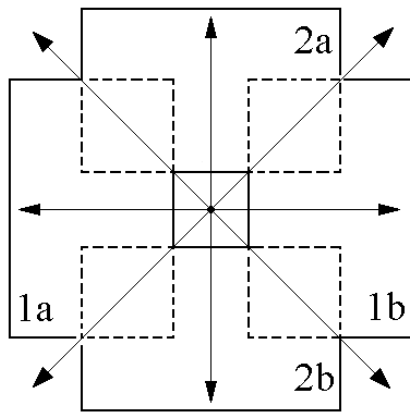
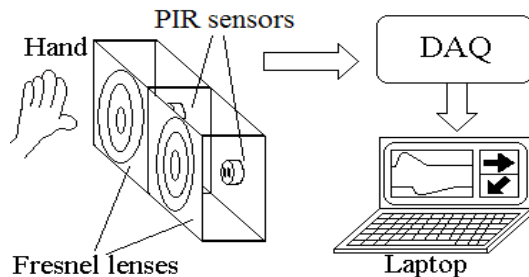

**Fig. 6.** Fields of view of two sensors if they are rotated by 90°, and 8 possible command paths; up, down, left, right, upper right, upper left, lower left, lower right

The formation of fields of view, in the system where two dual element PIR sensors are utilized, is illustrated in Fig. 6. It is assumed that the sensors are rotated by 90°, and a Fresnel lens is used for each of them. The elements of the first sensor are linked with areas 1a and 1b, while areas 2a and 2b correspond to the elements of the second sensor. On the one hand, if only horizontal or vertical commands are defined, the areas where fields of view overlay are uncertain. On the other, these are areas, where the object has to be moved to transmit diagonal commands.

### Experimental setup and results

The capabilities of the proposed approach have been verified using an experimental set-up. The structure of it is shown in Fig. 7. Detector system consists of 2 PIR sensors with a single segment Fresnel lens and a signal acquisition unit, which transmits data to a personal computer. PIR sensors were represented by low cost and low power consumption elements SDA02-54 from Nippon Ceramic Co., Ltd. This sensor has an angular visibility of 125° - 138°. The response of the sensor depends on the incident power collected by the elements, which in its turn depends on the sensitive area of the elements. This area of the elements in the set-up is about 2 mm<sup>2</sup>, and the amount of power collected is very small. To increase the sensitivity of the sensors, two separated Fresnel lenses made from inexpensive plastics with the desired transmission characteristics (for specific wavelength range) have been applied. We use TR1011 KUBE PIR single zone Fresnel lenses that absorb about 30 % of energy in 7-15 μm range and can be used for distances as far as 20 m. To operate at longer distances better and larger lenses could be used.



**Fig. 7.** Experimental setup

**Table 1.** Error rates of command identification at different distances

Distance	3m	5m	7m	10m
Error rate	8%	6%	10%	16%

Commands were produced by hand in 8 different paths as shown in Fig.6. Signals from the sensor output have been acquired by an acquisition unit and transferred to a laptop for further analysis. In the experimental set-up a DAQ card and LabVIEW software from National Instruments company were used. The adjustment of threshold levels and decoding of commands have been done in software.

The dependence of the error rate of command identification on the distance between radiation source and sensors is summarized in Table 1. 100 commands, which followed a random pattern, were sent and the percentage of incorrectly recognized commands was calculated. At each distance, adjustment of the angle of Fresnel lenses together with the infrared sensors has to be performed to orientate the fields of view as much as possible in accordance with Fig. 6. For better system performance the laser pointer can be used to mark the central point, where the hand must be before command transmission. It is visible from Table 1 that the error rate is quite high at all distances. The results show that the optimal distance is about 5 m in the case of the experimental set-up discussed.

Typically, errors appeared when a complicated combination of two commands had to be transmitted, for example, up and then again up. In order to reduce the error rate, the arbitrariness of the command sequence has been restricted. Table 2 shows the error rates of identification of commands, in the case where each command consists of two movements in reverse directions. To transmit one command the hand must be moved twice, for example, up and then down or down and then up. Thus four commands are formed: 1. up-down, 2. left-right, 3. upper left corner-lower right corner, 4. upper right corner-lower left corner. In this case the error rate reduces considerably.

**Table 2.** Error rates of identification of two successive reverse-direction commands at 5 m distance

Commands	↕	↔	↘	↙
Error rate	2%	2%	3.5%	4.5%

The error rate is also affected by other factors, for example, by the speed of hand movement and by the skills of the command sender. It is recommended that the hand be moved slowly and straight according to the axis. The voltage threshold of the decoding system has to be adjusted in accordance with the distance between the hand and sensors, because the magnitude of the output signal decreases when the sensor is located further. It should be noted that the increase of distance influences the size of fields of view and therefore the range of the hand movement has to increase as well.

## Conclusion

The use of infrared radiation for remote control can offer some interesting properties. In such a system it is possible to use as a transmitter any object with a temperature above absolute zero. The research presented was based on the hand movement as the source of information. Low cost pyroelectric detectors in combination with Fresnel lenses provide the possibility of detecting signals at a distance of up to 20 m. The signals at sensors outputs are compared with thresholds in order to analyze and identify the command.

To test the performance of proposed approach, an experimental set-up has been developed. Using this set-up the data have been analyzed at different distances. Error rates of identification of the commands were obtained. One of the main reasons for a high error rate is a "badly combined" sequence of successive commands. The dual element sensor senses the heat difference between its elements and therefore it is reasonable to use commands, where the hand is moved from central point in the desired direction and then returned back. In this case we produce two or four different pulses that form one command. Such a strategy increases the rate of correctly identified commands, but limits their diversity.

A PIR sensor based remote control unit can serve as a component for various electronic systems, where direct device control is not desirable or is dangerous. Another potential application area can be implementation in smart house equipment, for example, to turn lighting on or off, to change its intensity, to switch on music, to change volume or tracks. Typically the remote control system is based on

infrared diode or radio frequency transmitters, which require a power supply. The advantage of the proposed approach is that the infrared radiation of human body is used for transmission and there is no need for an additional supply.

Future plans are the implementation of the proposed approach in an embedded system and the enhancement of signal processing algorithms to improve the performance of the remote control system.

## References

1. **Mehra J., Rechenberg H.** The historical development of quantum theory: Volume 1, part 1, Springer (2001).
2. **Pollock D.** Thermoelectricity: Theory, thermometry, tool, ASTM International (1985).
3. **Spitzer V., Ackerman M., Scherzinger A., Whitlock D.** "The visible human male: A technical report," J. Am. Med. Assoc. 3, 118-130 (1996).
4. **Kakuta N., Yokoyama S., Nakamura M.** "Estimation of radiative heat transfer using a geometric human model," IEEE Trans. Biomed. Eng. 48, 324-331 (2001).
5. Technical Information SD-12 "Characteristics and use of infrared detectors", Hamamatsu Photonics K.K.. Cat. No. KIRD9001E03. Nov. 2004, (downloaded from [http://sales.hamamatsu.com/assets/applications/SSD/infrared\\_kird9001e03.pdf](http://sales.hamamatsu.com/assets/applications/SSD/infrared_kird9001e03.pdf))
6. **Webster J. G.** The measurement, instrumentation and sensors handbook, Springer, 109-11 (1999).
7. **Miller L. S., Mullin J.B.** Electronic materials: From silicon to organics, Springer (1991).

Submitted for publication 2007 03 15

**R. Fuksis, M. Greitans, E. Hermanis. Motion Analysis and Remote Control System using Pyroelectric Infrared Sensors // Electronics and Electrical Engineering. – Kaunas: Technologija, 2008. – No. 6(86). – P. 69–72.**

The paper discusses the possibilities of exploiting infrared radiation for motion analysis and remote control. The human body is considered as the information source and dual-element pyroelectric infrared (PIR) detectors as the sensor system. A dual-element sensor allows the analysis of the motion of objects in one-dimension, therefore it is proposed to place two sensors perpendicularly. Such a method provides the capability of distinguishing eight different commands. An experimental set-up has been developed in order to evaluate the performance of proposed approach. The signals at the sensors output are collected with a DAQ module and acquired data are entered into computer. The error rate of the system and its dependence on sensor-to-object distance are studied. The proposed remote control approach could be used to developed devices for smart houses. Il. 7, bibl. 7 (in English; summaries in English, Russian and Lithuanian).

**P. Фуксис, М. Грейтанс, Е. Германис. Система анализа движения и дистанционного управления использующая пирозлектрические инфракрасные сенсоры // Электроника и электротехника. – Каунас: Технология, 2008. – № 6(86). – С. 69–72.**

В данной работе обсуждаются возможности использования инфракрасного излучения для анализа движения и дистанционного управления. В качестве источника информации рассматривается тело человека, а в качестве сенсора использованы двухэлементные пирозлектрические инфракрасные детекторы. Сенсор с двумя элементами позволяет анализировать движение объекта только в одномерной плоскости, поэтому в данной работе предложено использовать два перпендикулярно расположенных сенсора. Данный подход позволяет распознавать восемь различных команд. Для оценки работы предложенного метода было разработано экспериментальное устройство. Информация, полученная от сенсоров поступает на DAQ модуль, а затем в персональный компьютер. В ходе работы была оценена вероятность ошибки в зависимости от расстояния от сенсора до объекта. Данное устройство дистанционного управления возможно найдет применение в "умных" домах (smart houses). Ил. 7, библи. 7 (на английском языке; рефераты на английском, русском и литовском яз.).

**R. Fuksis, M. Greitans, E. Hermanis. Judėjimo ir nuotolinio valdymo sistemų analizė taikant infraraudonuosius spindulius // Elektronika ir elektrotechnika. – Kaunas: Technologija, 2008. – Nr. 6(86). – P. 69–72.**

Išanalizuotos galimybės infraraudonuosius spindulius naudoti judėjimo analizei ir distanciniam valdymui. Šiuo atveju nagrinėjamas žmogaus kūnas kaip informacijos šaltinis, o dvigubas PIR jutiklis kaip jutiklių sistema. Dvigubas jutiklis leidžia analizuoti judėjimo objektus vienmatėje sistemoje, todėl siūloma du jutiklius išdėstyti statmenai. Pasiūlyto metodo tinkamumui nustatyti buvo atlikti bandymai. Jutiklių signalai susisteminti DAQ moduliui, ir duomenys apdoroti kompiuteriu. Iširta sistemos klaidos tikimybė priklausomai nuo atstumai tarp jutiklio ir objekto. Pasiūlytas nuotolinio valdymo metodas galėjo būti panaudotas prietaisams „protinguose namuose“. Il. 7, bibl. 7 (anglų kalba; santraukos anglų, rusų ir lietuvių k.).

DOI: 10.5755/j02.eie.11187