

Identification of the Electrical Resistance of Growing Condensate

V. Sinkevicius, D. Virzonis, L. Sumskiene, T. Jukna

Department of Electrical Engineering, KTU Panevezys Institute,

S.Daukanto str.12, 35212 Panevezys, Lithuania, phone:+370 45 434247, e-mail: vytenis@elekta.lt, darius.virzonis@ktu.lt

Introduction

The island stage, mono-atomic layers or self-organized derivatives are derivable producing nanostructures by vacuum technology – condensing the material vapour onto the other materials. These layers are too thin for traditional measurements of their resistance or thickness. Besides the most of electrical measurements are invasive and they are changing the conditions of condensation. In many cases the condensation process is interrupted and research of condensate state is carried out using the atomic force microscopy (AFM) or the methods of X-ray diffraction [1]. Unfortunately such methods of the research change further condition of condensation and the discontinuous mode is damaging for industrial devices. Indirect measurements of the thickness of condensing material using quartz–glass substrate [2] are not informative in point of the condensate structure, besides the conditions of the vapor condensation on each substrate are different [3]. The properties and structure of growing film also depend on the temperature of substrate [4], therefore it is necessary to carry out the condensation process continuously, without interruption for mediate measurements. The traditional methods of condensate resistance measurement [5, 6, 7], using the method of two or four contacts, allow us to measure the condensate resistance of the metal films and to find the dependence between its alternation and the condition of condensate. But the power switching during the course of measurement changes the conditions of condensation.

During the evaporation of material not only the atoms flow but also the electrons flow emitted by thermionic emission creates. This naturally created flow of electrons can be used for non-invasive measurement of condensate resistance and the other voltage supplies are not required. Some experimental researches showed that it is possible to get the information about the condensate resistance even in early stages of condensation and the extreme of the measured signal was right at the moment, when the condensate was in island stage. Also this method gives us the extra information about the state of evaporation process [8] and the possibility to control the intensity of material evaporation. The method of experimental research and the simplified mathematical

model of resistance measurement, which is afford for the identification of condensate resistance in-situ, are laid in this paper.

Experimental research

The system of experimental research is shown on Fig. 1. The evaporator 1 is heated by the alternating current, which is controlled by thyristor converter 2. Heated surface of the evaporator 1 and the evaporating material, which is in it, create the electrons flow of thermionic emission 3 flowing to the plane of the substrate 4. Also the positive ionize atoms can be in this flow. The substrate 4 is rectangular and has two pre-deposited contact sites 5, 6. The vapour of the evaporating material is condensing onto the plate of substrate 4 and contact sites. Also the electrons of thermionic emission take place onto them. The contact site 5 is connected to earth and the contact site 6 is wired with the input of the voltage measuring instrument 7, which is measuring the voltage U_p .

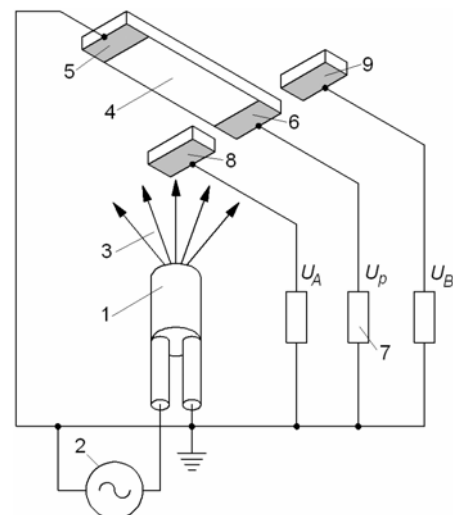

Fig. 1. Scheme of experimental research: 1 – evaporator, 2 – evaporator power supply, 3 – flow of emitted electrons and ionized atoms of evaporating material, 4 – the substrate, 5 – the contact site connected to earth, 6 – site of the substrate for the measurement of voltage, 7 – the input resistance of measuring instrument, 8, 9 – extra probes for identification of thermo electro moving force and its inner resistance

During the experimental research it was found, that the changing character of measured U_p depends on input resistance r_M of measuring instrument 7 directly. Metal probes 8, 9 were used as an extra implement for identification of thermo electro moving force E and the inner resistance r_E of the thermo electro moving force source. These two values are interdependent, but also are intermittent subject to the temperature of evaporator and the area of the evaporating material surface.

At the start of experiment the substrate 4, contact sites 5, 6 and the extra probes 8, 9 are under cover of shutter. This shutter is pushed aside, when the evaporating material reaches the due temperature and the velocity of the evaporation becomes steady. Now the flow of charges and vapor of material take place onto the surfaces of substrate, contact sites and onto extra probes also. The results of the typical experiment, condensing the chromium film, are shown on Fig. 2

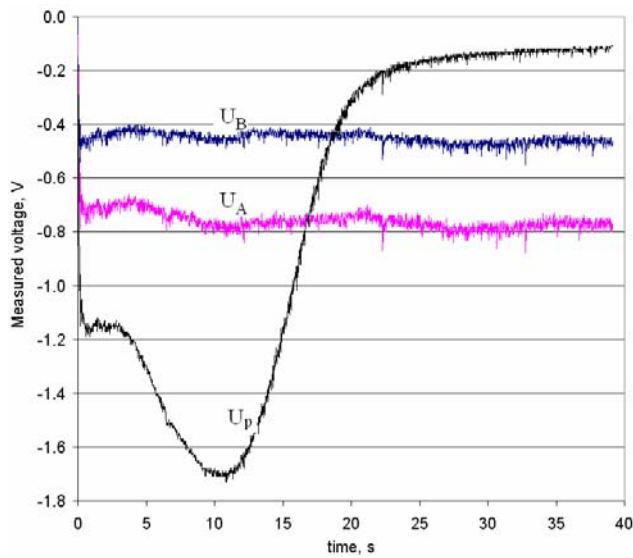

Fig. 2. The voltage of contact site U_p and the voltages of extra probes as the functions of time

The experimental research of condensate state demonstrated, that the condensate was in island stage (there was no continuous film on the substrate), when the voltage U_p reached the extreme value. In this state the resistance of condensate is in range from 1 to 10 M Ω and it is impossible to measure the resistance and the state of layer in the traditional non-invasive ways. However, exactly this state, constructing self-organized nanostructures, is interesting us most of all.

Simplified mathematical model

The simplified physical model (Fig. 3) and equivalent electrical scheme (Fig. 4) were created to understand the derivation of the alternation of the voltage U_p signal and its relationship with the condensate resistance of the substrate.

The rectangular oblong dielectric substrate, having width $b_p=10\text{mm}$, was used for experimental research. The contact sites of the conductor, having length $L_k=10\text{mm}$, were evaporated onto the edges of the substrate. The distance between contact sites is $L_p=18\text{mm}$ and the film is deposited on this length. The heated evaporator emits the

flow of charges and this together with the vapor flow of the evaporating material deposit onto the surface of the substrate. It is accepted, that this substance flows vertically to the surface of the substrate in this model. Therefore the density of the vapor and the charges is the same in any section (which area S_p) parallel to the surface of the substrate. Here i_E is the total current of the charges flow, taking place onto the substrate between contact sites.

It is accepted, that the all flow of the charges, flowing vertically in the area S_p (Fig. 3), deposits onto the central point of the substrate. The resistance r_p of the condensate, existing on the surface of substrate, divided two equal resistances, which outer edges connected to the contact sites and the inner connection point of them is the equivalent point of the all charges inflow.

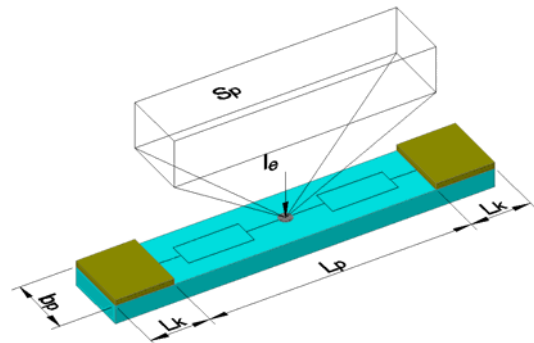

Fig. 3. The equivalent scheme of charges and resistances

The simplified equivalent scheme of condensate resistance measurement, without using the extra voltage or current source, is shown on Fig.4. The thermionic emission source of the evaporator is the voltage source E and r_E is its inner resistance in the model. In this case it is accepted, that the inner resistance r_E is the resistance of the channel of charges flow from the evaporator to the substrate through the area S_p . The condensate resistance of the substrate r_p is alternating during the condensation and we divide it two ways in the model. One contact of the substrate is connected to earth. The other contact is connected to voltage measuring instrument, which has an input resistance r_M . Charges, reaching the surface of the substrate, create two currents. Current i_m flows through the inner resistance of the measuring instrument r_M and creates the voltage drop U_p across the resistance r_M . This voltage drop is right the voltage of condensate on the contact site U_p , which is measuring (Fig. 2).

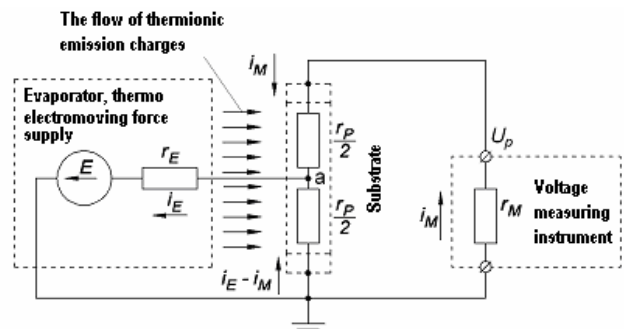

Fig. 4. The model of measuring the contact site condensate voltage U_p

The equation system (1) describes the currents of the model equivalent scheme (Fig.4):

$$\begin{cases} i_E r_E + (i_E - i_M) \frac{r_p}{2} = E, \\ (i_E - i_M) \frac{r_p}{2} - i_M \left(\frac{r_p}{2} + r_M \right) = 0. \end{cases} \quad (1)$$

From the equation system (1) the relationship between voltage U_p and the resistance of condensate r_p is as follows:

$$U_p = \frac{-2Er_p r_M}{r_p^2 + 2r_p(2r_E + r_M) + 4r_E r_M}. \quad (2)$$

In equation (2) values E and r_E are changeable during the experiment. Therefore they are identified by the extra probes measuring the voltages U_A and U_B . Figure 5 illustrates the signal U_p dependence on the substrate's resistance between contacts r_p , when r_p varies from $10^{10}\Omega$ to 100Ω . The values E and r_E are not steady during all the process, therefore for the calculations we choused these values only from the moment, when the voltage U_p reached the extreme during the experiment (Fig. 2). It is necessary to notice, that the calculated U_p by the equation (2) and the measured maximum value of the voltage $U_{max}(t)$ are very different at the moment of the extreme. And the reason of that is a large area of the contact of the substrate on which we are measuring the voltage.

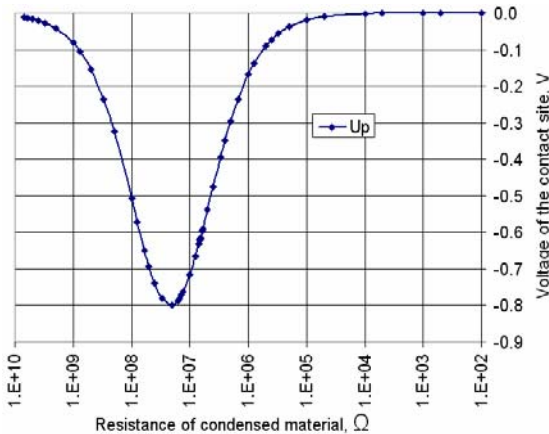

Fig. 5. Theoretical data of the substrate's voltage U_p as a function of the substrate's resistance r_p between contacts according to eq. (2)

The value and the place of the voltage U_p extreme can be evaluated from the fluxion of the equation (2) as follows:

$$\frac{d}{dr_p} U_p(r_p) = 0. \quad (3)$$

From the equation (3) we get, that the substrate's condensate resistance r_p , in which we reach the extreme of the measuring voltage U_p , evaluates as follows:

$$r_p = 2 \cdot \sqrt{r_E \cdot r_M}. \quad (4)$$

From the equations (4) and (2) we get the expression of the extreme of the substrate's condensate voltage U_{pMAX} :

$$U_{pMAX} = \frac{-E}{2 \cdot \sqrt{\frac{r_E}{r_M}} + 2 \cdot \frac{r_E}{r_M} + 1}. \quad (5)$$

It follows from the equation (5), that the maximum U_{pMAX} of the condensate voltage U_p is independent of the condensate resistance r_p , but in another way it depends on the resistance of the measuring instrument input r_M . Therefore it is the possibility to choose the place of the extreme and the maximum value of the voltage U_p , changing the resistance of the measuring instrument input (Fig. 6).

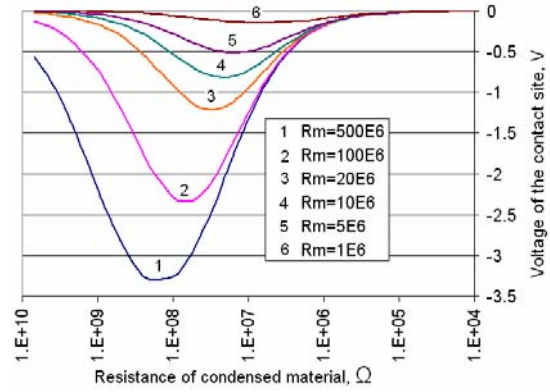

Fig. 6. Theoretical data of the substrate's voltage U_p as a function of the substrate's resistance r_p between contacts with different input resistance r_M according to eq. (2)

The identification of the condensate resistance

During the growing of the condensate the decrease of the substrate's condensate resistance r_p changes the value of the substrate voltage U_p . The experimental values of instantaneous voltage $U_p(t)$ and also the values $r_E(t)$, $E(t)$ identified by the voltages of probes $U_A(t)$ and $U_B(t)$ can be used for the calculation of the condensate resistance $r_p(t)$. Transforming the equation (2) and compensating the influence of the contact site, we get the expression of the substrate's condensate resistance $r_p(t)$ as follows:

$$\begin{cases} R_r(t) = 2r_E(t) + r_M \left(1 + \frac{E(t)U_{pMAX}}{U_p(t)U_{max}(t)} \right), \\ \begin{cases} r_{p1}(t) = -R_r(t) + \sqrt{R_r(t)^2 - 4r_E(t)r_M}, & t < t_{U_{pMAX}}, \\ r_{p2}(t) = -R_r(t) - \sqrt{R_r(t)^2 - 4r_E(t)r_M}, & t \geq t_{U_{pMAX}}. \end{cases} \end{cases} \quad (6)$$

The experimental function of the substrate's condensate resistance $r_p(t)$ is shown in Fig. 7. The initial researches showed us, that using the experimental data in equation (6) the identification of the condensate resistance is possible almost in all the area. Until U_{pmax} the decrease of the resistance r_{p1} , calculated by the equation (6), has slightly different character than the sequent decrease of the resistance r_{p2} . Probably it depends on the mathematical model, which underestimates rightly the influence of the contact site and the even distribution of the charges on the substrate. But here, on the initial stages of the condensation,

we can note the oscillations of the condensate resistance [7].

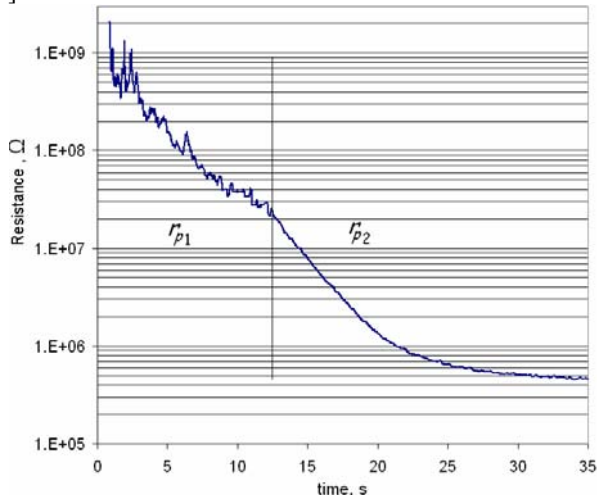

Fig. 7. The condensate resistance identified during the process

Conclusions

1. The resistance of the growing condensate in-situ can be measured in non-invasive way using naturally originated flow of the thermionic emission.

2. The mathematical model, describing non-invasive method of the condensate measuring, underestimates the area of the contact sites and the even distribution of the charges on the all area of the condensate.

References

1. Brajpuriyaa R., Tripathi S., Sharma A., Shripathi T., Chaudhari S. M. Thickness dependent structural and magnetic properties of ultra-thin Fe/Al structures // *The European Physical Journal B.* – 2006. – No. 51. – P. 131–136.
2. Dobierzewska-Mozrzymas E., Pieciul E., Bieganski P., Szymczak G. Conduction Mechanisms in Discontinuous Pt Films // *Crystal Research Technology.* – 2001. – No. 8–10(36). – P. 1137–1144.
3. Burkov A. T., Vinzelberg H., Schumann J., Nakama T., Yagasaki K. Strongly nonlinear electronic transport in Cr-Si composite films // *Journal Of Applied Physics.* – 2004. – No. 12(95). – P. 7903–7907.
4. Bishay A. G., Fikry W., Hunter H., Ragie H. F. Temperature coefficient of the surface resistivity of two-dimensional island gold films // *J. Phys. D: Appl. Phys.* – 2000. – V.33. – P. 2218–2222.
5. Dayal D., Rudolf P., Wibmann P. Thickness dependence of the electrical resistivity of epitaxially grown silver films // *Thin Solid Films.* – 1981. – V.79. – P. 193–199.
6. Schuisky M., Elam J. W., Georgea S. M. In situ resistivity measurements during the atomic layer deposition of ZnO and W thin films // *Applied Physics Letters.* – 2002. – No. 1(81). – P. 180–182.
7. Palasantzas G., Zhao Y., Wang G., Lu T., Barnas J., De Hosson J. Th. M. Electrical conductivity and thin-film growth dynamics // *Physical Review B.* – 2000. – No. 16(61) P. 109–117.
8. Virzonis D., Sinkevicius V. Increasing the observability of the thin films manufacturing process // *Electronics and Electrical Engineering.* – 2004. – No. 4(53). – P. 42–45.

Submitted for publication 2007 01 07

V. Sinkevicius, D. Virzonis, L. Sumskiene, T. Jukna. Identification of the Electrical Resistance of Growing Condensate // *Electronics and Electrical Engineering.* – Kaunas: *Technologija*, 2007 – No. 7(79). – P. 59–62.

The flow of the thermionic emission was used for non-invasive measurements of the growing condensate resistance. The mathematical and physical models were created for the simplification of the method of the resistance measuring. These models explain relationship between the alternation of the measured signal and the resistance of condensate. It was explored, that the extreme of the measured signal and the moment of its appearance depend on the input resistance of the measuring instrument. The instantaneous resistance of condensate was identified from the experimental signals. This method is right for the measuring of the condensate resistance, when the condensate is in the island stage. Ill. 7, bibl. 8 (in English; summaries in English, Russian and Lithuanian).

V. Синкявичюс, Д. Виржонис, Л. Шумскене, Т. Юкна. Идентификация электрического сопротивления растущего конденсата // *Электроника и электротехника.* – Каунас: *Технология*, 2006 – № 7(79). – С. 59–62.

Для безинвазивного измерения электрического сопротивления в вакууме растущей плёнки использован поток термоэлектронной эмиссии. Созданы упрощённые физические и математические модели этого метода измерения, объясняющие зависимости измеренного сигнала от сопротивления конденсата. Исследовано, что экстремум измеряемого сигнала и момент его появления зависит и от входного сопротивления измерителя напряжения. Из результатов измерения идентифицировано моментное сопротивление конденсата. Этот метод позволяет измерять сопротивление конденсата, когда он ещё в островковом состоянии. Ил. 7, библи. 8 (на английском языке; рефераты на английском, русском и литовском яз.).

V. Sinkevicius, D. Virzonis, L. Šumskienė, T. Jukna. Augančio kondensato elektrinės varžos nustatymas // *Elektronika ir elektrotechnika.* – Kaunas: *Technologija*, 2007 – Nr. 7(79). – P. 59–62.

Vakuume augančio kondensato elektrinės varžos neinvaziam matavimui panaudotas termoelektroninės emisijos elektronų srautas. Sudaryti šio varžos matavimo metodo supaprastinti fizikiniai ir matematiniai modeliai, paaiškinantys išmatuoto signalo kitimo priklausomybę nuo kondensato varžos. Iširta, kad matuojamo signalo ekstremumas ir jo pasirodymo momentas priklauso ir nuo įtampos matavimo prietaiso įėjimo varžos. Iš eksperimento metu gautų signalų nustatyta momentinė kondensato varža. Šis metodas tinka matuoti laidininkų kondensato varžai tuo metu, kai kondensatas yra dar salelinės būsenos. Il. 7, bibl. 8 (anglų kalba; santraukos anglų, rusų ir lietuvių k.).