

Magnetic Circuit of Nanometric Screw

R. Bansevicius, V. Grigaliunas

*Kaunas University of Technology, The Mechatronics Center for Research, Studies and Information
 Kestucio str. 27, Kaunas LT-44312, Lithuania, phone: +370-687-50284*

J.A. Virbalis

*Kaunas University of Technology, The Department of Theoretical Electrical Engineering
 Studentu str. 48, Kaunas LT-51367, Lithuania, phone: +370-699-84937*

Introduction

Modern technologies cannot manage without precision Mechatronics devices. Devices with a nanometric resolution are used in precision positioning systems, actuators of optical and electronic microscopes, various precision measurement devices. In many cases a stroke of these devices must be sufficiently large, sometimes reaching several tenths of a millimetre.

It is very complicated to obtain a nanometric resolution by purely mechanical means. It is proposed [1] how to generate nanodisplacements using terfenol-D – magnetostrictive material which have very large magnetostriction, while magnetic field is created by a permanent magnet. In this case an external power source is not necessary.

When investigating the simplest magnetic circuit, consisting of a permanent magnet, air and terfenol-D rod was faced with two problems [1]. The first one was nonlinear mean magnetic flux density dependence inside terfenol-D rod vs distance between terfenol-D and permanent magnet, especially in case of small distances. The second problem was non-uniform distribution of magnetic flux inside terfenol-D rod. The terfenol-D is a brittle material; to avoid mechanical stresses the main part of magnetic flux must be directed along the terfenol-D rod.

Both problems can be solved using special magnetic circuit of a ferromagnetic material for magnetic flux canalization.

Basic design of nanometric screw

We investigate a nanometric screw, in which micrometric and nanometric displacements are generated separately and independently from each other. A construction of the screw is given in Fig.1. Micrometric displacements δ_1 are formed by the micrometric screw 1, mounted in a plate 2. The terfenol-D rod 3 is mounted between the micrometric screw with thread and thimble 4. When the micrometric screw 1 is turned by an angle φ_1 ,

the thimble 4 can move without restriction through the hole in the plate 5 (because a clearance of the order of several micrometers is between the hole edge and thimble).

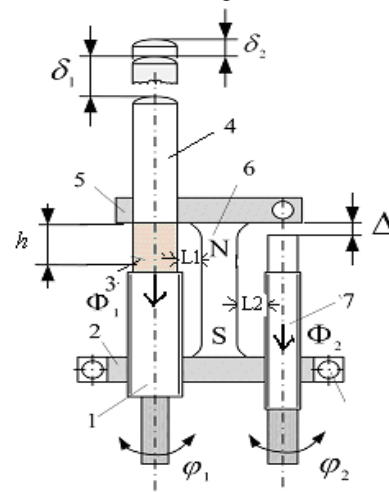

Fig. 1 Basic design of nanoscrew

The magnetic flux created by the permanent magnet 6 is directed through two parallel pathways. Nanometric displacement is created by magnetic flux Φ_1 , directed through terfenol-D rod 3 and trough the left side of plates 2 and 5. The parallel branch consists of right side of plates 2 and 5 and micrometric screw 7, which controls the air gap Δ between plate 5 and thimble of screw 7. The magnetic flux Φ_2 circulates in this pathway. The screws 1 and 7 together with plates 2 and 5 are made of ferromagnetic material.

The air gap Δ between plate 5 and thimble of screw 7 can be controlled by turning the screw 7 by angle φ_2 . The magnetic resistance of this pathway is changed too and magnetic fluxes is redistributed. By making the air gap wider, the flux Φ_2 decreases and the flux Φ_1 increases and vice versa. The strain of the terfenol-D rod depends on a rod length and the flux Φ_1 . We obtain nanometric

resolution of terfenol-D rod thimble displacement δ_2 , by varying the air gap Δ in the parallel pathway.

For small variations of the magnetic flux inside the terfenol-D the dependence of magnetostrictive displacement vs. magnetic flux is assumed to be linear [2]. Therefore it is important, that the dependence of magnetic flux Φ_1 vs. air gap Δ should be linear too.

Investigation of basic nanoscrew design

It is complicated to analyze dependence $\Phi_1(\Delta)$ using mathematical analysis. The magnetic field distribution dependence on the air gap Δ is shown in Fig. 2.

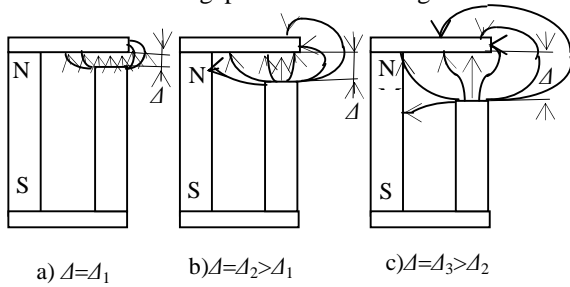

Fig. 2. The distribution of magnetic flux for different air gaps values Δ .

We cannot use the circuit analysis methods because it is not possible to express mathematically the magnetic resistance at the air gap. The reason why it is not possible to get exact solution by magnetic field theory is the presence of many surfaces and edges with different orientation. This dependence was investigated by modeling applying finite elements method, using software package COSMOS/M. The investigation technique is described in [1]. The distribution of the magnetic flux density axial component B_y along the terfenol-D rod in relation to air gap Δ was obtained. Modeling results are presented in Fig. 3 and 4. The dependence of ratio $B_{yv}(\Delta)/B_{yv}(0)$ on air gap Δ is presented in Fig. 3, where $B_{yv}(\Delta)$ is the mean value of magnetic flux density axial component at the entire terfenol-D rod volume, when the air gap is Δ , $B_{yv}(0)$ – the same value when $\Delta=0$. The first curve is obtained when $L1=L2=4\text{mm}$ in Fig.3 and a relative permeability of the ferromagnetic material $\mu_r=100$. The second curve is obtained when $L1=4\text{mm}$, $L2=1\text{mm}$, $\mu_r=100$, and the third - $L1=L2=4\text{mm}$, $\mu_r=300$, where $L1$ is the distance between the edges of permanent magnet and terfenol-D rod, $L2$ – the distance between edges of permanent magnet and nanometric screw 7 (Fig.1). The dependence of the ratio $B_y(h)/B_y(0)$ on h is shown in Fig.4, where h is the axis, directed along the terfenol-D rod (Fig.1). $B_y(h)$ is the mean value of magnetic flux density in the area of cross-section $h=\text{const}$, $B_y(0)$ is the same value in the cross-section $h=0$. These dependences are obtained for $L1=L2=4\text{mm}$, $\mu_r=100$.

It can be seen from Fig. 3, that the dependence $B_{yv}(\Delta)$ is extremely nonlinear at initial and very large Δ values. For intermediate Δ values the non-linearity is moderate. We also can see from Fig.4, that for intermediate values of $\Delta=(0,25\dots 0,75)\Delta_{\text{max}}$ the axial component of the magnetic flux density B_y is distributed non-uniformly along terfenol-D rod axis. It is because the part of magnetic flux is

directed through the air. The component of a magnetic flux, which is perpendicular to an axis along the rod, is originated. The terfenol-D rod is affected by this transversal magnetic flux component.

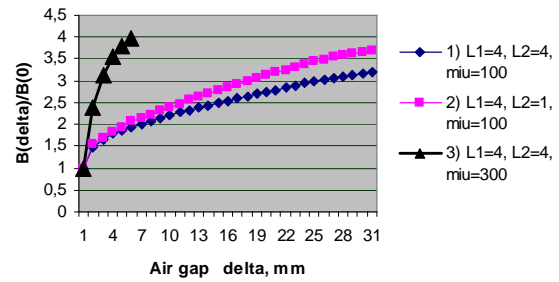

Fig. 3. The dependence of relative magnetic flux density, $B_{yv}(\Delta)/B(0)$, versus air gap, Δ , in the nanoscrew design

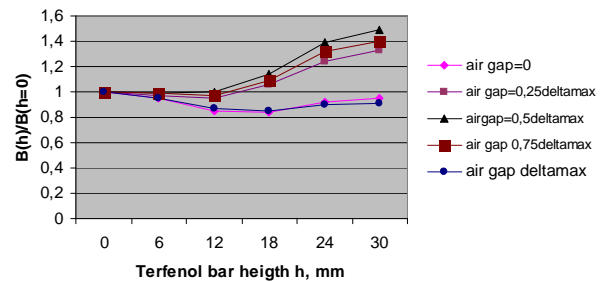

Fig. 4. The dependence of relative magnetic density mean value in the cross-section $h=\text{const}$, $B_{yv}(h)/B_{yv}(0)$, versus h in the nanoscrew design for different Δ .

Investigation of a modified nanoscrew design

The dependence $B_y(\Delta)$ is non-linear because the magnetic flux at the air gap is distributed non-uniformly. We can avoid the non-linear field distribution at the air gap using a ferromagnetic screen, which surrounds simultaneously the screw 7 and the air gap Δ at the basic nanoscrew design. The cross-section of the right part of the nanometric screw (Fig. 1) after modification is presented in Fig. 5a.

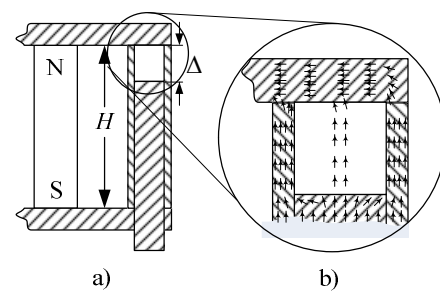

Fig. 5. Modification of nanoscrew magnetic circuit: modified air gap, b) magnetic flux distribution

Magnetic flux distribution at the air gap and its surrounding is presented in Fig.5b. The magnetic flux is nearly uniform at the most part of magnetic circuit. The reason to appear of transversal magnetic flux components is practically reduced to zero.

We investigate the magnetic circuit of modified design by circuit analysis methods. The equivalent electric circuit of the modified nanoscrew is presented in Fig.6. In this circuit R_{mF1} and R_{mF2} are the magnetic resistances of

plate 2 and 5. Respectively R_{mT} – the magnetic resistance of the terfenol-D rod, R_{m0} – the magnetic resistance of a peripheral flux, Φ_p , through the air, R_{ma} – the magnetic resistance of an air gap, R_{mSn} – the magnetic resistance of the screw 7, R_{mE1} – the magnetic resistance of the part of ferromagnetic screen at the air gap Δ , R_{mE2} – the magnetic resistance of the remaining part of ferromagnetic screen. Suppose, that $\Phi_2 \gg \Phi_p$, $\Phi_1 \gg \Phi_p$ and $R_{m0} \rightarrow \infty$, then

$$\delta\Phi_2 = \frac{\Phi_0 R_{m1}}{R_{m1} + R_{mF2} + R_{mvar}(\Delta_1)} - \frac{\Phi_0 R_{m1}}{R_{m1} + R_{mF2} + R_{mvar}(\Delta_2)}, \quad (1)$$

where

$$R_{m1} = R_{mT} + R_{mF1}, \quad (2)$$

R_{mvar} – the equivalent resistance of the magnetic resistances R_{mE1} , R_{mE2} , R_{ma} and R_{mSn} .

We evaluate this resistance using denotes:

H – distance between plates 2 and 5 (see Fig. 5 and Fig.1):

$$n = \frac{\Delta}{H}, \quad R_{mE} = R_{mE1} + R_{mE2}, \quad R_{mS} = R_{mSn}|_{\Delta=0, n=0}. \quad (3)$$

Let us make assumption that ferromagnetic parts of magnetic circuit are uniform, then we can write:

$$\begin{aligned} R_{mE1} &= nR_{mE}, \quad R_{mE2} = (1-n)R_{mE}, \quad R_{mSn} = (1-n)R_{mS}, \\ R_{ma} &= nR_{ma0}. \end{aligned} \quad (4)$$

The resistances R_{mE} , R_{mS} and R_{ma0} can be expressed:

$$R_{mE} = \frac{H}{\mu_r \mu_0 S_E}, \quad R_{ma0} = \frac{H}{\mu_0 S_a}, \quad R_{mS} = \frac{H}{\mu_r \mu_0 S_S}, \quad (5)$$

where S_E , S_a and S_S are the cross-section of respective magnetic circuit parts.

From (4) and (5), supposing that $\mu_r \gg 1$, we obtain:

$$\begin{aligned} R_{mvar} &= \frac{R_{mE1} \cdot R_{ma}}{R_{mE1} + R_{ma}} + \frac{R_{mE2} \cdot R_{mS}}{R_{mE2} + R_{mS}} = \\ &= R_{mE} \left[n \frac{R_{ma0}/R_{mE}}{1 + R_{ma0}/R_{mE}} + (1-n) \frac{R_{mS}/R_{mE}}{1 + R_{mS}/R_{mE}} \right] = \\ &= R_{mE} \left[n \frac{\mu_r A}{1 + \mu_r A} + (1-n) \frac{A}{1 + A} \right] \cong \frac{R_{mE}}{A+1} (n + A), \end{aligned} \quad (6)$$

where

$$A = S_E/S_a. \quad (7)$$

By putting equation (6) to the expression (1), it can be changed this way:

$$\begin{aligned} \delta\Phi_2 &= \frac{\Phi_0 R_{m1}}{R_{m1} + R_{mF2} + [A/(A+1)]R_{mE} + n_2[R_{mE}/(A+1)]} - \\ &- \frac{\Phi_0 R_{m1}}{R_{m1} + R_{mF2} + [A/(A+1)]R_{mE} + n_1[R_{mE}/(A+1)]} \cong \\ &\cong \frac{\Phi_0 R_{m1} (A+1)}{R_{mE}} \frac{-\delta n}{(D+n_2)(D+n_1)}, \end{aligned} \quad (8)$$

where

$$\delta n = n_2 - n_1, \quad (9)$$

$$D = \frac{R_{m1} + R_{mF2}}{R_{mE}} (A+1) + A. \quad (10)$$

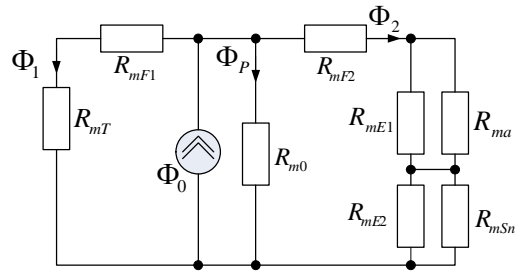

Fig. 6. The equivalent electric scheme of the modified nanoscrew magnetic circuit

A maximal flux $\Phi_2 = \Phi_{2max}$ will be when $\Delta=0$, $n=0$. From equivalent electric scheme (Fig.6) and expressions (6) and (7) we obtain:

$$R_{mvarmin} = R_{mE} [A/(A+1)], \quad (11)$$

$$\Phi_{2max} = \frac{R_{m1} \Phi_0}{R_{mF2} + R_{m1} + R_{mE} [A/(A+1)]} = \frac{R_{m1} \Phi_0 (A+1)}{R_{mE} D}, \quad (12)$$

$$\begin{aligned} \frac{\delta\Phi_2}{\Phi_{2max}} &= \frac{-\delta n D}{(D+n_2)(D+n_1)} = \frac{-\delta n D}{(D+n_1)^2 [1 + \delta n / (D+n_1)]} \cong \\ &\cong \frac{-D}{(D+n_1)^2} \left[\delta n - \frac{\delta n^2}{(D+n_1)} \right]. \end{aligned} \quad (13)$$

Magnetic flux variation through the terfenol-D rod is equal to flux variation through the screw 7 with inverse sign: $\delta\Phi_1 = -\delta\Phi_2$. The magnetic flux through the terfenol-D is minimal when magnetic flux through the screw 7 is maximal: $\Phi_{1min} = \Phi_0 - \Phi_{2max}$. The relative Φ_1 variation evaluating equation (12) are:

$$\frac{\delta\Phi_1}{\Phi_{1min}} = -\frac{\Phi_{2max}}{\Phi_{1min}} \frac{\delta\Phi_2}{\Phi_{2max}} = \frac{(R_{m1}/R_{mE})[(A+1)/D]}{1 - (R_{m1}/R_{mE})[(A+1)/D]} \frac{\delta\Phi_2}{\Phi_{2max}}. \quad (14)$$

Evaluating (10) and (13) finally we obtain:

$$\frac{\delta\Phi_1}{\Phi_{1min}} = \frac{(R_{m1}/R_{mE})}{R_{mF2}/R_{mE} + A/(A+1)} \frac{D}{(D+n_1)^2} \left[\delta n - \frac{\delta n^2}{D+n_1} \right]. \quad (15)$$

Therefore, the relative variation of magnetic flux $\delta\Phi_1$ linearly depends on $\delta n = n_2 - n_1$ with nonlinearity error γ_N :

$$\gamma_N = \frac{-(R_{m1}/R_{mE})D\delta n^2}{R_{mF2}/R_{mE} + A/(A+1)(D+n_1)^3}. \quad (16)$$

We can ensure acceptable nonlinearity by choosing the constants of magnetic circuit, which depend on design and range δn of n variation.

The theoretical analysis was verified by modelling. The modelling was done with the following dimensions and parameters: $L1=4mm$ and $L2=4mm$, relative permeability $\mu_r=100$, ratios $A=S_E/S_S=1,0$, $R_{mF2}/R_{mE}=1,25$, $R_{m1}/R_{mE}=2$. From (10) was obtained $D=7,5$. The results of modelling are presented in Fig.7 and 8. As could be seen from Fig.7, the dependence $B_y(\Delta)/B(0)$ is practically linear.

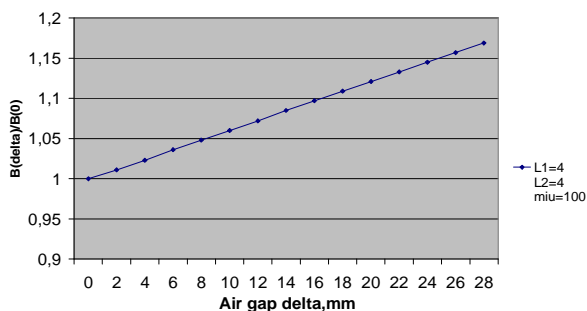

Fig. 7. The dependence of relative magnetic flux density $B_y(\Delta)/B(0)$ vs. Δ for modified design of nanoscrew

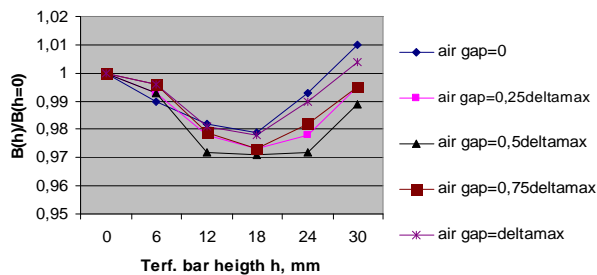

Fig. 8. The dependence of relative magnetic flux density $B(h)/B(0)$ in cross-section $h=\text{const}$ versus h , for different air gap values Δ in modified design of nanoscrew

From Fig. 8 it is seen that the distribution of magnetic flux density axial component $B_y(h)$ along whole terfenol-D rod is approximately uniform. Therefore, independently on the air gap value, there is no transversal magnetic flux components.

R. Bansevicius, V. Grigaliunas, J. A. Virbalis. Magnetic Circuit of Nanometric Screw // Electronics and Electrical Engineering. – Kaunas: Technologija, 2009. – No. 3(91). – P. 67–70.

The system is investigated, in which micrometric displacements are obtained by mechanical means and nanometric displacements - by variation of magnetic flux directed through magnetostrictive material terfenol-D. The permanent magnet is used as a magnetic flux source. A parallel branch to terfenol-D rod's magnetic circuit branch enables to form nanometric and micrometric displacements separately and independently. Nanometric displacements are formed by variation of the air gap at the parallel branch. It is recommended to shield the air gap by ferromagnetic screen. In this case the dependence of magnetic flux through the terfenol-D rod versus the air gap is practically linear. Ill. 8, bibl. 2 (in English; summaries in English, Russian and Lithuanian).

P. Бансевичюс, В. Григалиюнас, Ю. А. Вирбалис. Магнитная цепь нанометрического винта // Электроника и электротехника. – Каунас: Технология, 2009. – № 3(91). – С. 67–70.

Исследуется винт, в котором микрометрические сдвиги получаются механическими средствами, а нанометрические сдвиги - формируя изменения магнитного потока через магнитострикционный материал - терфенол-D. В качестве источника магнитного потока используется постоянный магнит. Чтобы избежать механических напряжений в терфеноле-D, магнитный поток формируется вдоль образца терфенола-D. Для этого разработана специальная ферромагнитная цепь, направляющая созданный магнитом поток в нужном направлении. Образование параллельной образцу терфенола-D ветви магнитной цепи дает возможность нанометрические и микрометрические сдвиги формировать раздельно и независимо. Нанометрические сдвиги формируются изменяя воздушный зазор параллельной ветви. Чтобы получить достаточно линейную зависимость магнитного потока через терфенол-D от величины воздушного зазора, рекомендуется воздушный зазор закрыть ферромагнитным экраном. Ил. 8, библи. 2 (на английском языке; рефераты на английском, русском и литовском яз.).

R. Bansevicius, V. Grigaliunas, J. A. Virbalis. Nanometrinių sraigto magnetinė grandinė // Elektronika ir elektrotechnika. – Kaunas: Technologija, 2009. – Nr. 3(91). – P. 67–70.

Nagrinėjamas sraigtas, kuriame mikrometriniai poslinkiai gaunami mechaninėmis priemonėmis, o nanometriniai poslinkiai - formuojant magnetinio srauto pokyčius per magnetostrickinę medžiagą - terfenolą-D. Kaip magnetinio srauto šaltinis naudojamas nuolatinis magnetas. Sudarant lygiagrečią su terfenolo-D strypeliu magnetinės grandinės šaką, nanometriniai ir mikrometriniai poslinkiai formuojami atskirai ir nepriklausomai. Nanometriniai poslinkiai formuojami keičiant lygiagrečios šakos oro tarpą. Norint gauti pakankamai tiesišką magnetinio srauto pokyčio priklausomybę nuo oro tarpo pokyčio, oro tarpą rekomenduojama pridengti feromagnetiniu ekranu. Il. 8, bibl. 2 (anglų kalba; santraukos anglų, rusų ir lietuvių k.).

Conclusions

1. Nanometric displacements can be obtained by variation of magnetic flux through magnetostrictive material - terfenol-D. As the source of magnetic flux the permanent magnet can be used.
2. Creating parallel pathway to the terfenol-D rod's magnetic circuit and changing its air gap enables to generate nanometric and micrometric displacements separately and independently.
3. The dependence of magnetic flux through the terfenol-D rod versus the air gap is practically linear, when the air gap is shielded with ferromagnetic screen.

Acknowledgements

This research was funded by Lithuanian State Science and Studies Foundation (Project PiezoAdapt, 2008).

References

1. Bansevicius R., Grigaliunas V., Virbalis J. A. Investigation of Magnetic Circuit Permanent Magnet – Terfenol-D - Air // Electronics and Electrical Engineering. – 2008. – No. 6(86). – P. 3–6.
2. Guruswamy S., Loveless M., Srisukhum-bowornchai N., McCarter M., Teter J. Processing of Terfenol-D Alloy Based Magnetostrictive Composites by Dynamic Compaction // IEEE Transactions on Magnetics. – September 2000. – Vol. 36, No. 5. – P. 3219–3222.

Received 2008 12 16

