

Approximation T - U Characteristics of Analog Semiconductors Temperature Sensors

A. Dumčius

Department of Electronics Engineering, Kaunas University of Technology,
Studentų str. 50-142, LT-51368 Kaunas, Lithuania, phone: +370 37 300520, e-mail: antanas.dumcius@ktu.lt

T. Žizniakovas

Kaunas University of Technology,
Studentų str. 50, LT-51368 Kaunas, Lithuania, phone: 8 618 85057, e-mail: tomynis@gmail.com

Introduction

There are some classes of semiconductors temperature sensors: resistance output sensors; voltage output sensors; current output sensors; analog output sensors; digital output sensors.

The contemporary analog semiconductor sensors of temperature are made on the technology of integrated circuits, then instead of the diode adapts the transistor, whose collector is connected with the base.

The principle of the analog voltage output temperature sensor is that the forward voltage of the base-emitter voltage of a transistor is temperature and current dependent, according to the following equation [1]

$$U_{BE} = U_{B0} \left(1 - \frac{T}{T_0} \right) + U_{B10} \left(\frac{T}{T_0} \right) + \left(\frac{nkT}{q} \right) \ln \left(\frac{T}{T_0} \right) + \left(\frac{kT}{q} \right) \ln \left(\frac{I_E}{I_{E0}} \right), \quad (1)$$

where U_{B0} – band gap voltage at absolute zero, U_{B10} – band gap voltage at temperature T_0 and current I_{C0} , I_E and I_{E0} – emitter current values.

The T - U characteristics of analog voltage output temperature sensors type LM35 and LM35A has same nonlinearity [2, 3]. Therefore there is an interest to investigate nonlinearity their characteristics [4].

The experiment

The block diagram of experiment is shown in Fig. 1.

During first run of measurements dry-well thermostat was used, while during second and third run of measurements oil-bath thermostat was used. It was made three runs of measurements. The first run – 10 sensors type LM35 was heated in the dry-well thermostat to the temperature 90°C and then slowly in the time-span 5.6

hours they were cooled in the thermostat to temperature 20°C . The duration of each temperature and output voltage measurement cycle it was 9 s. Second run of measurements was made with another group of 10 sensors type LM35 at four points of temperature between 0°C and 100°C , and the third run under the same conditions with the 10 sensors type LM35A.

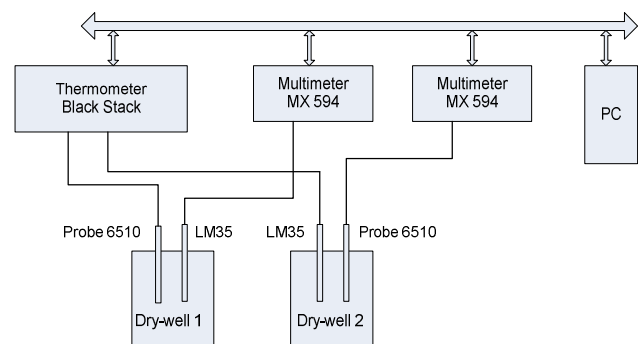

Fig. 1. The structure of measurement equipment

The experiment equipment: the temperature measurements – thermometer Black Stack model 1560, eight channels Thermistor scanner module 2564 and two secondary thermistor probes type 5610. Thermistor scanner module accuracy was $\pm 0.0025^{\circ}\text{C}$ at 0°C and secondary thermistors probes accuracy was $\pm 0.015^{\circ}\text{C}$ in temperature range 0°C to 100°C [5]. Temperature sensors type LM35 output voltage was measured by digital multimeter type MX 594, this accuracy was ± 0.001 V.

The main features of temperature sensor type LM35: linear + 10.0 mV/ $^{\circ}\text{C}$ scale factor; 0.5°C accuracy (at $+25^{\circ}\text{C}$); temperature range -55° to $+150^{\circ}\text{C}$; nonlinearity $\pm 0.25^{\circ}\text{C}$ typical [2]. And sensor type LM35A: linear + 10.0 mV/ $^{\circ}\text{C}$ scale factor; 0.2°C accuracy (at $+25^{\circ}\text{C}$); temperature range -55° to $+150^{\circ}\text{C}$; nonlinearity $\pm 0.18^{\circ}\text{C}$ typical [3].

Results of experiments

Temperature sensors type LM35. The results of measurement $U-T$ (output voltage–temperature) reliance for one of temperature sensor type LM35 as illustration is shown in Fig. 2.

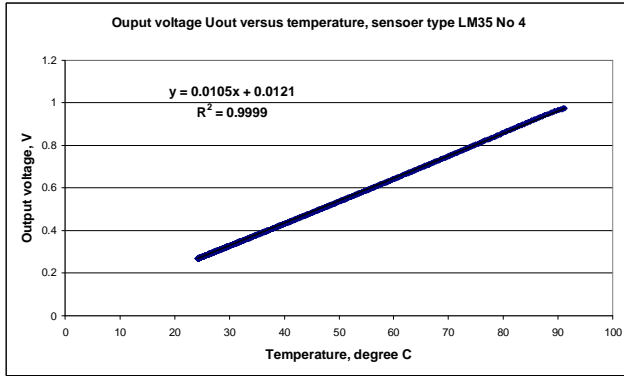

Fig. 2. Sensor LM35 output voltage versus temperature in cooling cycle

The regression equation for $U-T$ characteristic for sensors type LM35 can be given in the form

$$y = a + b x. \quad (2)$$

The general regression equation was calculated on the basis of measurement $U-T$ characteristic data of 10 sensors type LM35 is given by

$$U_{out} = 0.0186 + 0.00962 * T, \quad (3)$$

where U_{out} – sensor output voltage, V,
 T – reference temperature, $^{\circ}\text{C}$.

The values of regression equation (4) coefficients a and b and their standard deviation for 10 sensors LM35 it is shown in Fig. 3.

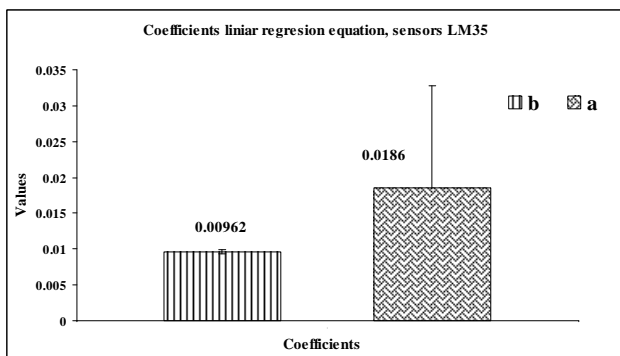

Fig. 3. Values of regression equation coefficients a and b and their standard deviation

The spread of coefficient a for the measured characteristics $U-T$ of 10 sensors the type LM35 is more the spread of coefficient b ($p < 0.05$).

Among the measured 10 sensors there were same sensors for which a spread of coefficients was

comparatively small (see Fig. 4). So if it is a necessarily it is possible to select the pairs of sensors with the assigned spread of the values of coefficients.

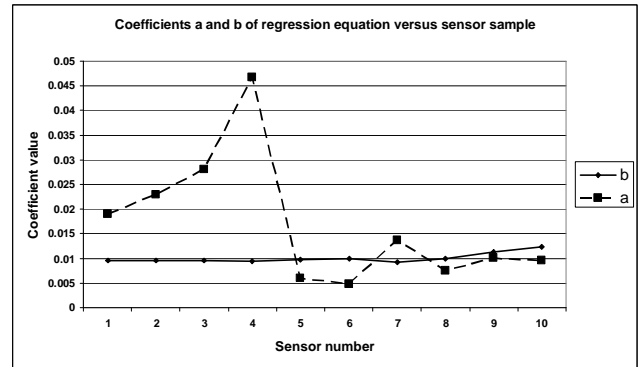

Fig. 4. Coefficients a and b of regression equation versus sensor sample

More precise approximation can be obtained by using the polynomial of the corresponding degree.

The general polynomial of the second power for calculating the temperature according to the results of measuring the output voltage of 10 sensors type LM35 takes the form

$$U_{out} = 0.221 + 0.00918 * T + 0.00000498 * T^2. \quad (4)$$

The average values of the coefficients a , b and c of second power equation and their standard deviation for 10 sensors LM35 it is shown in Fig. 5.

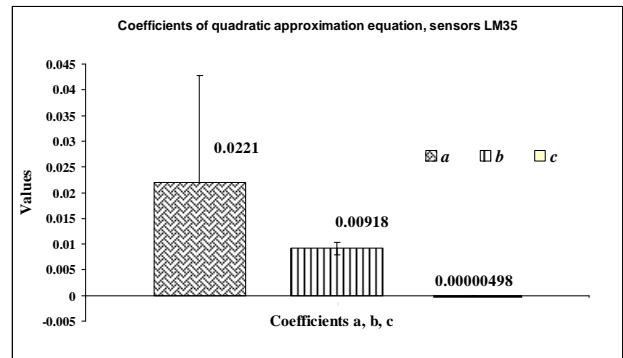

Fig. 5. The average values of the coefficients of polynomial of the second power and their standard deviation

Above it was shown that sensors of the type LM35 it has the specific $U-T$ characteristic nonlinearity; therefore has sense to estimate an error in the approximation according to the results of measurement.

The linear equation for calculating the temperature for the results ($n=1453$) of measuring output voltage of the sensor type LM35 No 4 takes the form

$$T_{cal\ linear} = 94.790 * U_{out} - 1.121. \quad (5)$$

The results of calculation the difference between reference temperature T_{ref} measured by thermometer and it

calculated according to the equation (5) $T_{cal\ linear}$ is shown in Fig. 6.

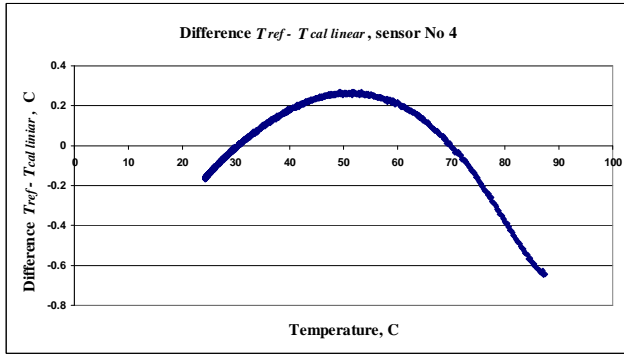

Fig. 6. Difference between reference temperature T_{ref} , measured by thermometer and calculated $T_{cal\ linear}$

The polynomial of the second power for calculating the temperature according to the results of measuring the output voltage of sensor type LM35 No 4 takes the form

$$T_{cal\ quadr} = -5.348*U_{out}^2 + 100.615*U_{out} - 2.464 \quad (6)$$

The results of calculation the difference between reference temperature T_{ref} , measured by thermometer and it calculated according to the equation (6) $T_{cal\ quadr}$ for sensors LM35 is shown in Fig. 7.

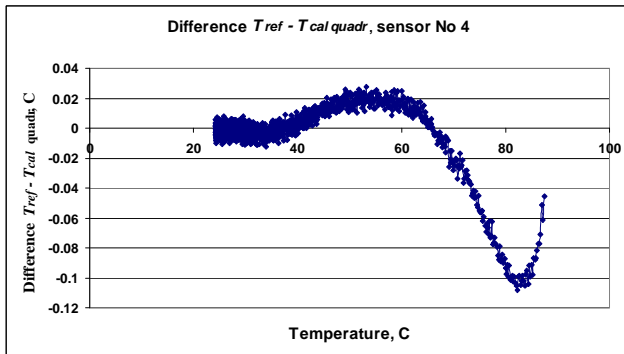

Fig. 7. Difference between reference temperature T_{ref} , measured by thermometer and calculated $T_{cal\ quadr}$

Temperature sensors type LM35A. The general regression equation was calculated on the basis of measurement $U-T$ characteristic data of 10 sensors type LM35A is given by

$$U_{out} = 0.00159 + 0.009981711*T. \quad (7)$$

The values of equation (7) coefficients a and b and theirs standard deviation it for 10 sensors LM35A is shown in Fig. 8.

The general polynomial of the second power for calculating the temperature according to the results of measuring the output voltage of 10 sensors type LM35A takes the form

$$U_{out} = 0.000934 + 0.00999*T + 0.000000101*T^2. \quad (8)$$

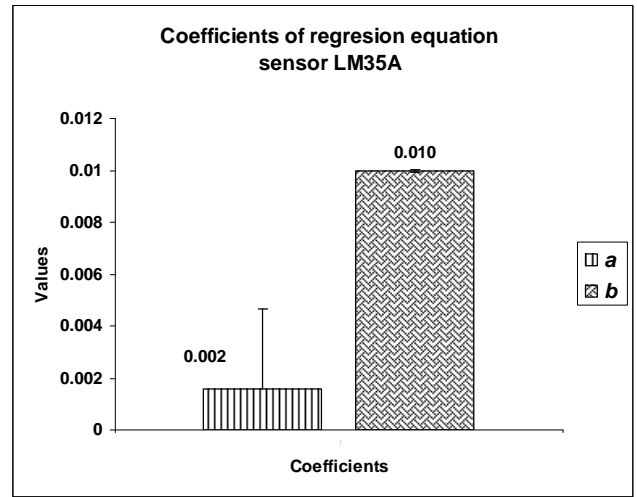

Fig. 8. Values of regression equation coefficients a and b and theirs standard deviation (sensors LM35A)

The average values of the coefficients a , b and c of second power equation (8) and their standard deviation for 10 sensors LM35A it is shown in Fig. 9.

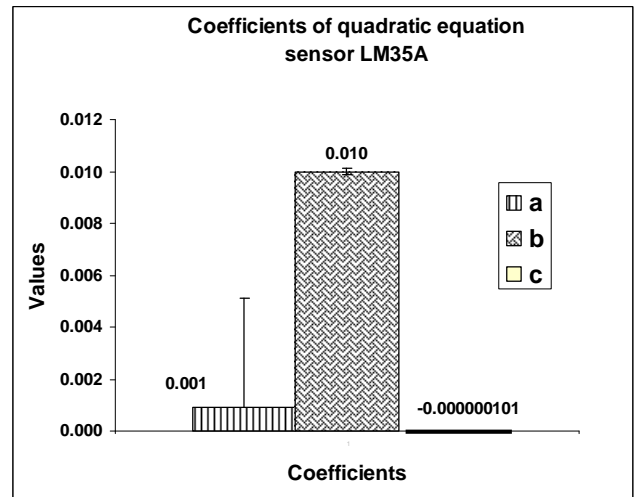

Fig. 9. The average values of the coefficients of polynomial of the second power and their standard deviation

The linear equation for calculating the temperature from the results of measuring of the sensor type LM35A No 7 output voltage of sensor takes the form

$$T_{cal\ linear} = 100.19*U_{out} - 0.084. \quad (9)$$

The results of calculation the difference between reference temperature T_{ref} , measured by thermometer and it calculated according to the equation (9) $T_{cal\ linear}$ is shown in fig. 10.

The polynomial of the second power for calculating the temperature according to the results of measuring the sensor LM35A No 7 output voltage of sensor takes the form

$$T_{cal\ quadr} = -0.102*U_{out}^2 + 100.166*U_{out} - 0.0277. \quad (10)$$

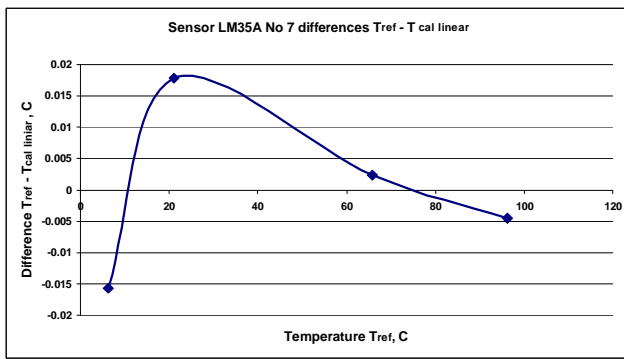

Fig. 10. Difference between reference temperature T_{ref} , measured by thermometer and calculated $T_{cal\ linear}$

The results of calculation the difference between reference temperature T_{ref} , measured by thermometer and it calculated according to the equation (7) $T_{cal\ quadr}$ for sensors LM35A No 7 is shown in Fig. 11.

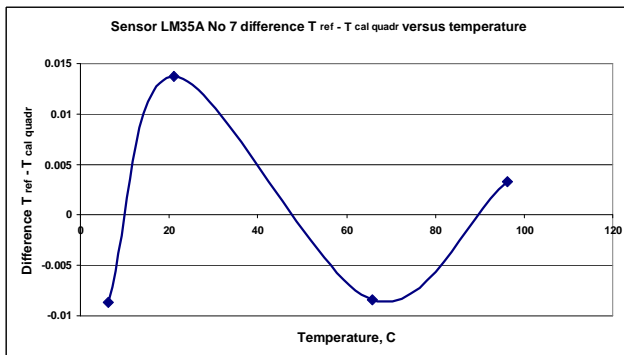

Fig. 11. Difference between reference temperature T_{ref} , measured by thermometer and calculated $T_{cal\ quadr}$

Conclusions

1. Major part of an error in the determination temperature by analog sensor type LM35 introduces the initial spread of the sensor output voltage at the temperature 0°C .
2. With the precise calibration of sensors of type LM35 a smaller uncertainty in the determination of temperature can be obtained with the approximation $U-T$ characteristic by the polynomial of the second power.
3. By the polynomial of the first and second power in range from 20°C to 90°C it is not established for the sensors type LM35A an essential difference with the approximation.

References

1. Bakker A., Beijing J. High-accuracy CMOS smart temperature sensors. – Kluwer Academic Publishers, Boston, 2000.
2. LM35 Data Sheet. National Semiconductor Corporation. [Online]. – Available at: <http://www.national.com/mpf/LM/LM35.html>.
3. LM35A Data Sheet. National Semiconductor Corporation. [Online]. – Available at: <http://www.national.com/mpf/LM/LM35A.html>.
4. Dumčius A., Augutis V., Gailius D. Control of the temperature in the fluid flow by the semiconductor sensors // Elektronika ir elektrotechnika. – Kaunas: Technologija, 2007. – Nr. 7(87). – P. 27–30.
5. Hart scientific. A Fluke company catalog. – 2007. – Accessed at: <http://www.hartscientific.com>

Received 2008 04 11

A. Dumčius, T. Žizniakovas. Approximation T-U characteristics of analog semiconductors temperature sensors // **Electronics and Electrical Engineering**. – Kaunas: Technologija, 2009. – No. 1(89). – P. 105–108.

T-U characteristics of the analog temperature sensors of types LM35 and LM35A are investigated. It is obtained that a basic error of measurement of temperature introduces the spread of output voltage at 0°C . It is evaluated an error in the determination of temperature from the output voltage of sensor in the cases of approximation by the polynomials of the first and second power. Smaller error is obtained during the application of a polynomial of the second power. It is obtained that with the precise calibration of sensors of the type LM35 the smaller error the determination of temperature can be obtained with the approximation by the polynomial of the second power. It is not established for the sensors of the type LM35A of essential difference. Il. 11, bibl. 5 (In English; summaries in English, Russian and Lithuanian).

A. Думчюс, Т. Жизняковас. Аппроксимация T-U характеристик аналоговых полупроводниковых сенсоров температуры // **Электроника и электротехника**. – Каунас: Технологія, 2009. – № 1(89). – С. 105–108.

Исследованы T-U характеристики аналоговых сенсоров температуры типов LM35 и LM35A. Получено, что основную погрешность измерения температуры вносит разброс выходного напряжения при 0°C . Оценена погрешность определения температуры по выходному напряжению сенсора в случаях аппроксимации полиномами первой и второй степени. Меньшая погрешность получена при применении полинома второй степени. Получено, что при точной калибровке сенсоров типа LM35 меньшую погрешность определения температуры можно получить при аппроксимации полиномом второй степени. Для сенсоров типа LM35A существенного различия не установлено. Ил. 11, библи. 5 (на английском языке; рефераты на английском, русском и литовском яз.).

A. Dumčius, T. Žizniakovas. Analoginių temperatūros jutiklių T-U charakteristikų aproksimavimas // **Elektronika ir elektrotechnika**. – Kaunas: Technologija, 2009. – Nr. 1(89). – P. 105–108.

Nagrinėjamos analoginių temperatūros jutiklių LM35 ir LM35A T-U charakteristikos. Daugiausia įtakos sensorių išėjimo įtampos neapibrėžčiai turi išėjimo įtampos nuokrypiai esant 0°C temperatūrai. Aproksimuojant T-U charakteristikas pirmos ir antros eilės polinomais nustatyta, kad LM35 tipo jutikliams geriau naudoti antros eilės polinomą. Temperatūros jutiklių LM35A charakteristikų aproksimavimo pirmos ir antros eilės polinomais skirtumo nenustatyta. Il. 11, bibl. 5 (anglų kalba; santraukos anglų, rusų ir lietuvių k.).

DOI: 10.5755/j02.eie.10590