

Influence of External Electromagnetic Disturbance on the Optical Fiber Properties in WDM Systems

J. Porins, G. Ivanovs, O. Dzerins

Institute of Telecommunications, Riga Technical University

Azenes st. 12, LV-1010 Riga, Latvia, phone: +371 27896222, e-mail: jurgis.porins@rtu.lv

Introduction

The need for broadcasting channels is determined by the up-to-date progress, since the electronic communication is now changing from passive modes (reviewing the internet home pages, sending e-mails, etc.) to active ones (video-conferences, activities in virtual environment, etc). The need to the access of information generates progress of wide development of fiber optic communication systems by wavelength division multiplexing (WDM). Transmission of the high optical power, dense channel spacing or the combination of both is used for increasing the capacity of the optical long-haul communication systems and in telecommunication fibers are influenced by nonlinear optical effects because small core diameters lead to significant light intensities even at moderate signal powers [1]. So far, it was considered that the optical fiber does not affect the external electromagnetic interference [6].

There are three basic phenomena which limit the capacity of fiber WDM systems - chromatic dispersion, polarization mode dispersion and nonlinear optical effects [1].

In principle, external electric, magnetic and electromagnetic (EM) fields can affect light transmission in optical fibers through Kerr effect, Faraday effect and Pockels effect.

The determining factor for NOE is the medium polarization, which for a stationary medium can be expressed in a simplified manner (not taking into account spatial scattering and assuming that all waves spread one-dimensionally) with the series [2]:

$$\begin{aligned}
 P_i(t) = & \varepsilon_o X_{ij}^{(1)}(\omega_s) E_j(\omega_s) e^{i\omega_s t} + \\
 & + \varepsilon_o X_{ijk}^{(2)}(\omega_s, \omega_i) E_j(\omega_s) E_k(\omega_i) e^{i(\omega_s + \omega_i)t} + \\
 & + \varepsilon_o X_{ijkl}^{(3)}(\omega_s, \omega_i, \omega_n) E_j(\omega_s) E_k(\omega_i) E_l(\omega_n) e^{i(\omega_s + \omega_i + \omega_n)t} + \\
 & + c.c.
 \end{aligned} \quad (1)$$

In series (1), $\chi_{ij}^{(1)}$, $\chi_{ijk}^{(2)}$, $\chi_{ijkl}^{(3)}$ are the tensors of dielectric susceptibility of the material of the first (linear), second (quadratic), and third (cubic) order, respectively,

which in the general case are complex values; $E_j(\omega_s)$, $E_k(\omega_i)$, $E_l(\omega_n)$ are the complex amplitudes of the components ($i, j, k, l = x, y, z$) of the light electric field vectors acting in the material with cyclic frequencies ω_s , ω_i , ω_n and so on, where t is the time and i is the imaginary unit. In equation (1) the summation by repeated indexes j , k , l ... and s , l , $n = 1, 2, 3$... is assumed. This is correct in the case when we are dealing with a spectrum of discrete frequencies. If this spectrum is continuous, the summation should be replaced by integration with variables ω_s , ω_i , ω_n . The dependence of dielectric susceptibility tensors on a , b , c , d ... characterizes the material anisotropy, whereas the frequency dependence – its dispersion with time. Both the mentioned factors essentially influence NOE. The expansion (1) is valid if the electric field frequencies ω_s , ω_i , ω_n are far from the resonance frequencies of the material and the field amplitudes are much smaller in modulus than the atomic frequencies (10^6 - 10^8 V/cm). In order that the latter condition is fulfilled, it is sufficient for light intensities to be $I < 10^9$ W/cm² for semiconductors and $I < 10^{13}$ W/cm² for dielectrics [2].

The first term in expansion (1), which is linearly dependent on $E_j(\omega_s)$, describes linear optical effects – i.e. the light refraction, induced polarization, and emission. In this case $P_i(t)$ oscillates with the same frequency (or frequencies) as $E_j(\omega_s)$. Other terms, which depend nonlinearly on $E_j(\omega_s)$, $E_k(\omega_i)$, $E_l(\omega_n)$, and so on, describe the following nonlinear optical effects.

1. The second term of Eq. (1) – the quadratic polarization-determines the second harmonic generation, sum and difference frequency generation, parametric luminescence, and optical rectification. In the materials with the centre of inversion the second order susceptibility is zero. So in normal fibers $\chi_{ijk}^{(2)} = 0$. However, the centre of inversion is lost in presence of magnetic field and thus Faraday effect is possible in standard optical fibers.

2. The third term of Eq. (1) – cubic polarization-determines the third harmonic generation, four-photon interaction, four-photon parametric luminescence, nonlinear refraction, Raman and Mandelstam-Brillouin scattering, and two-photon absorption.

As it is well known, Kerr effect is based on the material refractive index changes depending on the electromagnetic field strength. Optical Kerr effect is the refractive index change affecting the intensity of light beam spread as optical fiber [1]. Kerr effect is proportional to the square the field and depends of refractive index n and temperature T . It changes the polarization of propagating light. According to [9], external electric field can effectively rotate the polarization plane of light in the fiber due to the Kerr effect by the angle

$$\varphi = 2\pi K(\lambda)E^2l, \quad (2)$$

where K – Kerr coefficient ($K=f(n,T)/\lambda$; E – electric field strength).

The Kerr coefficient depends on the wavelength and assuming that the solids approximation anisotropic molecules turning in a similar way as a liquid or gaseous substance that is obtained [9]:

$$K = \frac{1}{30} \frac{(n^2 - 1) \cdot (n^2 + 2)}{n} \cdot \frac{m\varepsilon_0}{\lambda k T \rho}, \quad (3)$$

where ε_0 – electric constant; m – particle mass of mater; λ – wavelength; k – Boltzmann's constant; T absolute temperature (Kelvin's).

Research of author [8, 9] shows, that turning the plane of polarization can occur even on 45° to 90° if optical fiber affects strong lighting, which are becoming dangerously WDM systems. Changes of plane of polarization can be cause double refraction and two mutually orthogonally wave components occurrence in optical fibers [2].

We expect and calculations confirm this conclusion, that influence of external electromagnetic disturbance in optical fibers becomes more expressed in WDM systems, especially in long-span high density WDM (HDWDM) systems, when channel spacing is minimal.

System setup

In our research the system parameter analysis is based on optical signal-to-noise ratio (OSNR) and bit error rate (BER) calculation by using OptSim 5.0 simulation software. OSNR fully characterizes the noise performance of the system [4]. We have also decided to show calculations, spectrum and eye diagrams for various simulation setups, since they are a fast way how to approximately evaluate a system performance. The simulation provides toolboxes and blocksets for setting any complicated system configuration under the test. Spectral characteristics of new transmission performance with focus to the tolerance of different effects including changes of polarization, polarization mode dispersion etc. can be easily change [7].

The method of calculation is based on solving a complex set of differential equations, taking into account optical and electrical noise, linear and nonlinear effects [6]. In practice, dispersion and non-linearity are mutually interactive while the optical pulse propagate through fiber and in calculation methods assumes over a small length and the effects of dispersion and the nonlinearity on the

propagation optical field are independent [7] We used model where signals are propagating as time domain samples over a selectable bandwidth (in our case, a bandwidth that contains all channels). The Time Domain Split Step (TDSS) method is used to simulate linear and nonlinear behavior for both optical and electrical components. The Split Step method is used in all commercial simulation tools to perform the integration of the fiber propagation equation:

$$\frac{\partial A(t, z)}{\partial z} = \{L + N\}A(t, z). \quad (4)$$

In equation (1) $A(t, z)$ is the optical field, L – linear operator that stands for dispersion and other linear effects, N – operator that is responsible for all nonlinear effects. The idea is to calculate the equation over small spans of fiber Δz by including either linear or nonlinear operator. For instance, on the first span Δz only linear effects are considered, on the second – only nonlinear, on the third – again only linear and so on.

Simulation scheme and parameters

The main idea of our simulation is to demonstrate the influence of electromagnetically disturbance effect to the polarization and polarization mode dispersion in WDM systems. We use a simplified approach rotating the polarization artificially by a certain angle and then calculating the light propagation characteristics and system performance.

Our simulation scheme consists of 3 main sections: transmitter section, receiver section and fiber itself. Such configuration is common for most fiber optical communication links, because, first of all, we need to prepare incoming bit stream for propagating via optical fiber, then we have to configure the fiber and, finally, the signal has to be correctly detected at the end [3].

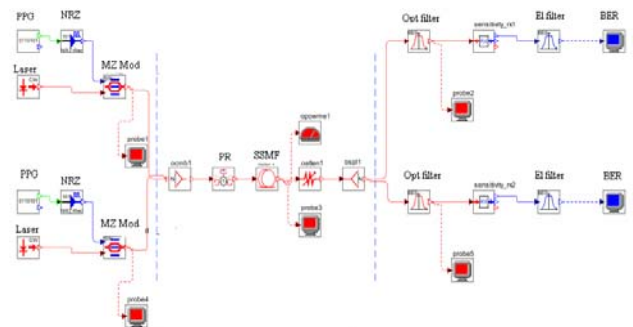

Fig. 1. Simulation scheme of WDM system

The transmitter block consists of 16 multiplexed channels, each of them, consist of data source, NRZ driver (NRZ), and continue wavelength laser source (Laser) and external Mach-Zehnder modulator (MZ Mod) [3]. The data source produces a 10,52 Gbit/s bit stream and the signal is transmitted to a standard single mode fiber (SSMF) ITU-T G.652D, where optical pulses are propagating via 40 km length. The used fiber has a large core effective area $80 \mu m^2$, attenuation $\alpha = 0.2$ dB/km, and nonlinear refractive coefficient $n_k = 2.5 \cdot 10^{-20}$ cm/W at the reference wavelength

$\lambda = 1550$ nm [3]. The laser emits an output field polarized along the X axis, with no corresponding Y-polarized component. The polarization of the field can be changed using the polarization rotator component and polarization will be change by angles $\varphi=1^\circ, 2^\circ \dots n$ by different polarization mode dispersion (PMD). In the receiver each channel is optically filtered by Bessel filter with bandwidth 22 GHz (Opt filter). In receiver, whose sensitivity is -15dBm (sensitivity_rx), signal is converted to the electrical signal and filtered by electrical filter (El filter). To analyze system parameters several measurements are used. The idea is to compare system performance when using different PMD values, laser powers, and frequency intervals between the channels. After transmission and filtering each channel could be analyzed separately. After that, each channel is optically filtered, converted to electrical and then electrically filtered. When evaluating system performance, we are interested in observing optical spectrum at the end of optical link [3, 4].

To change the polarization, in simulation will be added polarization rotator cutters, which will take polarization rotation using Stokes parameters along Poincare fields axes with a fixed angle (see Fig. 2 and Fig. 3).

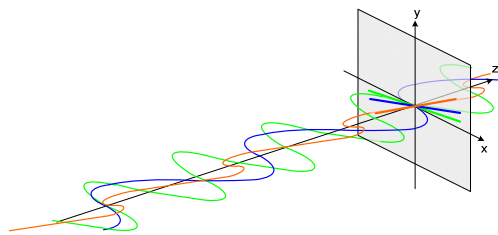

Fig. 2. Polarization in optical fibers

Longer waves spread near the vertical axis, while the shortest horizontal (see Fig. 7). This means that the waves will be longer with more vertical polarization. The magnetic field affects the light is spread along the axis of the magnetic field strength, polarization, rotation occurs along.

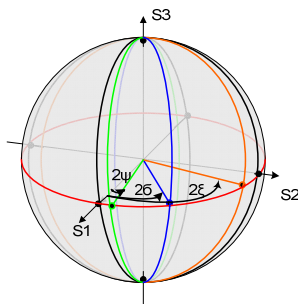

Fig. 3. Changes in plane of polarization in optical fibers depicted on Poincare sphere

Results and discussions

In our simulation with the spacing channels from 50 GHz to 100 GHz in wavelength 1546 nm - 1554 nm range was studied. With polarization rotator was adjusted calculated polarization angle and polarization mode value. In Fig. 4, is spectrum on output. NRZ modulation method, 50 GHz channels interval, and 0.1 ps/√km PMD value.

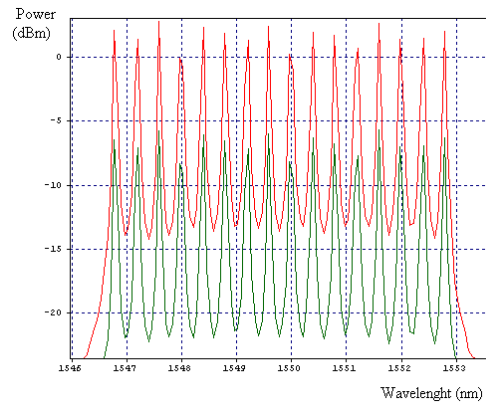

Fig. 4. Superimposed spectrum on output and input NRZ modulation method, 50 GHz channels interval, and 0.1 ps/√km PMD value

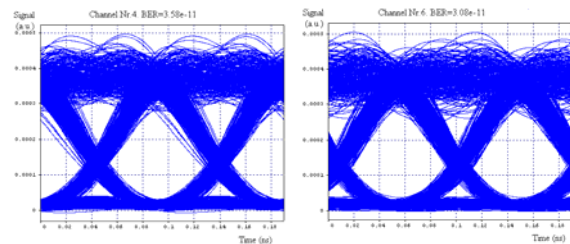

Fig. 5. 10.52 Gbit/s WDM system with 40 km SSMF eye diagram on output, 50 GHz channel spacing

In Fig. 5 is presented our calculated optical signal output for 16 channels WDM system after 40 km of SSMF. The reason why we take 40 km is associated with two aspects – ITU-T organization recommendation and our experimental line. This example shows that an optimal transfer mode. The power level of this harmonics is enough for new channels detection on output. From Fig. 6 we can see the same WDM line, but with change of polarization plane by φ . The results show BER changes from 10^{-11} to 10^{-9} which is close to critical by ITU-T recommendations.

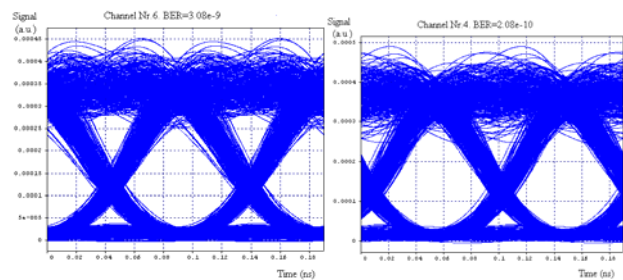

Fig. 6. 10.52 Gbit/s WDM system with 40 km SSMF eye diagram on output, 50 GHz channel spacing by $\varphi=1^\circ$

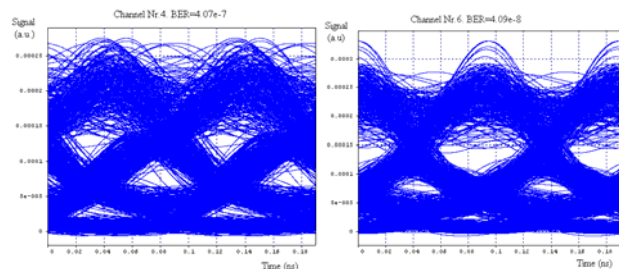

Fig. 7. 10.52 Gbit/s WDM system with 40 km SSMF eye diagram on output, 50 GHz channel spacing with $\varphi=45^\circ$

As we can see, from Fig. 7, what happens if input signal level increase dramatically. The results show BER changes from 10^{-11} to 10^{-7} which is critical for system performance.

Conclusions

Influences of external electromagnetic disturbance on the optical fiber properties in WDM systems have been studied. The results show the changes of parameters in WDM systems, where different polarization and dispersion levels presented.

In WDM systems, which are working on a SSMF base, this effect leads to the necessity of a significant increase of the spectral distance between channels, because otherwise polarization changes and dispersion can significantly reduce the performance of WDM system due to the channel crosstalk. For example, in the 45° polarization rotation case when using 50 GHz spacing between the channels it is necessary to increase the spacing up to around 100 GHz. Modeling a system with a capacity of a channel 1 mW, enough in to increase step around 100 GHz. It should be noted that various optical devices are sensitive to the change of polarization, for example isolators, Raman amplifiers etc.

References

1. **Agrawal G. P.** Fiber-Optic communication systems (Second edition). - The institute of Optics University of Rochester, 2001. – 555 p.
2. **Agrawal G. P.** Nonlinear fiber optics. – San Diego: Academic Press, 2001. - 452 p.
3. **Bobrovs V., Makovejs S., Porins J., Ivanovs G.** Demonstration and Analysis of Dual Nature of Stimulated Raman Scattering in Fiber Optical Communications Systems// Latvian Journal of Physics and Technical Sciences 2006., No 2, -pp. 34-46
4. **Bobrovs V., Ivanovs G.** Parameter Evaluation of a Dense Optical Network // Electronics and Electrical Engineering. – 2006. – No. 4(25). – P. 33-37.
5. **Derickson D., Muller M.** Digital Communications Test and Measurement. Boston, Personal Education,– 2008. -953p.
6. **Keiser G.** Optical Fiber Communications. – NewYork, etc. Mc Graw-Hill. 1991. - 461 p
7. **Le Nguyen B.** Digital optical communications systems // CRC press. Boca Raton– 2009. 579 p.
8. **Соколов С.А.** Возникновение поляризационной модовой дисперсии под действием грозовых разрядов// Электросвязь, 2004. –No. 11, 100.-103.с.
9. **Соколов С.А.** Особенности поляризационной модовой дисперсий в оптическом кабеле с волновым уплотнением при ударе молнии // Первая Российская конференция по молнезащите. Сборник докладов, -2007. 111.-114.с.

Received 2009 02 14

J. Porins, G. Ivanovs, O. Dzerins. Influence of External Electromagnetic Disturbance on the Optical Fiber Properties in WDM Systems // Electronics and Electrical Engineering. – Kaunas: Technologija, 2009. – No. 4(92). – P. 57–60.

The influence of external electromagnetic disturbance on the optical fiber properties in WDM systems have been studied with OptSim 5.0 simulation software. The obtained results show that electromagnetically induced polarization changes in WDM systems, which are working on a SSMF base can severely reduce the system performance. Therefore, the channel spacing must be increased. For example, in the case of 45° polarization rotation the spacing increase from 50 GHz to 100 GHz is necessary. Ill. 7, bibl. 9 (in English; summaries in English, Russian and Lithuanian).

Ю. Поринс, Г. Ивановс, О. Дзеринс. Влияние внешних электромагнитных помех на свойства оптического волокна системы WDM // Электроника и электротехника. – Каунас: Технология, 2009. – № 4(92). – С. 57–60.

Влияние внешних электромагнитных помех на свойства волоконно-оптических устройств WDM систем были изучены при помощи OptSim 5.0 программного обеспечения. Полученные результаты свидетельствуют о том, что электромагнитно индуцированная помеха меняет поляризацию в WDM системах, которые работают на базе SSMF. Это может сильно снизить производительность системы. Таким образом, интервал канала передачи должен быть увеличен. Например, в случае поворота плоскости поляризации на 45° интервал увеличивается от 50 ГГц до 100 ГГц. Ил. 7, библ. 9 (на английском языке; рефераты на английском, русском и литовском яз.).

J. Porins, G. Ivanovs, O. Dzerins. Išorinių elektromagnetinių trukdžių įtakos optinio pluošto savybėms tyrimas WDM sistemoje // Elektronika ir elektrotechnika. – Kaunas: Technologija, 2009. – Nr. 4(92). – P. 57–60.

Ištirta išorinių elektromagnetinių trukdžių įtaka optinio pluošto savybėms WDM sistemoje. Tyrimas atliktas naudojant modeliavimo programinę įrangą OptSim 5.0. Rezultatai rodo, kad elektromagnetinškai sukurta poliarizacija WDM sistemoje, kurios veikia SSMF pagrindu, keičiasi ir gali gerokai sulėtinti sistemos darbą. Taigi, minimalų atstumą tarp kanalų būtina padidinti. Pavyzdžiui, pasukus poliarizacijos plokštumą 45° , atstumas tarp gretimų kanalų padidėjo nuo 50 GHz iki 100 GHz. Il. 7, bibl. 9 (anglų kalba; santraukos anglų, rusų ir lietuvių k.).

DOI: 10.5755/j02.eie.10245