

Realization of Optimal FBG Band–Pass Filters for High Speed HDWDM

O. Ozoliņš, Ģ. Ivanovs

Scientific Institute of Telecommunications, Riga Technical University

Azenes st. 12, LV-1010 Riga, Latvia, phone: +371 20011193, e-mail: oskars.ozolins@etf.rtu.lv

Introduction

Optical wavelength division multiplexing (WDM) communication systems are forging ahead towards higher data transmission rate and lower channel spacing to utilize available bandwidth more effectively [1]. Increasing spectral efficiency is important for building efficient WDM communication systems, since this allows the optical infrastructure to be shared among many WDM channels, and thus reduces the cost per transmitted information bit in a fully loaded system [2].

Numerous variations of data transmission rates from 2.5 Gbit/s to 40 Gbit/s and channel spacing ranging from 200 GHz to 25 GHz (and lower) are currently being explored. High performance optical filters are groundwork for realization of high speed dense WDM communication systems where coherent crosstalk between adjacent WDM channels becomes a main source of degradation: adjacent channels interfere with each other upon detection, and the resulting beating gives rise to signal distortions, provided that the beat frequencies lie within the bandwidth of the detection electronics [2].

Low channel spacing and high data transmission rate sets strict requirements for WDM filter characteristics and any imperfections in their parameters, such as amplitude and phase responses, becomes critical. Understanding and distracting of those optical filter imperfections to high speed dense WDM communication systems are of great importance [1].

One realization of optical filtering is based on fiber Bragg grating (FBG) filters. A FBG is periodic variation of the refractive index along the propagation direction in the core of optical fiber that reflects particular wavelengths of light and transmits all others [1].

Low channel isolation from adjacent channels is one of these imperfections in optical filter parameters. To ensure high channel isolation we need to inscribe FBG filters with complex apodization profiles. Changes in apodization profiles emerge in different filter bandwidth at -3 dB and -20 dB level and suppression of undesirable side lobes in optical filter amplitude response.

In this paper we demonstrate performance of three different apodization profiles and their influence on high speed dense WDM systems main parameters: channel spacing and data transmission rate. We foresee that lower channel spacing and higher data transmission rate WDM systems will need FBG optical filters with inscribed more complex apodization profiles.

System setup

To evaluate impact of different FBG apodization profiles on high speed dense WDM communication system we used combination of two different simulation programs.

Firstly, we used Bragg Grating Filters Synthesis 2.6 (BGFS 2.6) simulation program for mathematical description of FBG optical filter. In the simulation program we realized different FBG optical filters with defined apodization profiles. This simulation program is based on Transfer Matrix Method. This method is used to simulate periodic non-uniform FBG filters. It is applied to solve the coupled mode equations and to obtain the spectral response of the fiber Bragg grating. In this approach, the grating is divided into uniform sections. Each section is represented by a 2×2 matrix. By multiplying these matrices, a global matrix that describes the whole grating is obtained (see Fig. 1. and equation 1):

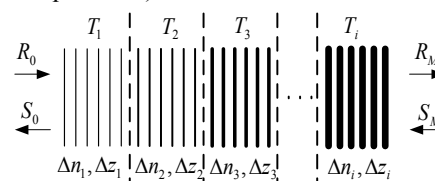

Fig.1. Transfer matrix method used to obtain the spectral characteristics of a fiber Bragg grating (Δn - average index of refraction, Δz - section length, R_0, S_0, R_M, S_M - electromagnetic waves amplitudes)

$$\begin{cases} T_M = T_1 \cdot T_2 \cdot T_3 \cdot \dots \cdot T_i, \\ \begin{bmatrix} R_M \\ S_M \end{bmatrix} = T_M \cdot \begin{bmatrix} R_0 \\ S_0 \end{bmatrix}. \end{cases} \quad (1)$$

The reflection coefficient of the entire grating is defined as:

$$\rho = \frac{S_0}{R_0}. \quad (2)$$

The main drawback of this method is that M may not be made arbitrarily large, since the coupled-mode theory approximations are not valid when uniform grating section is only a few grating periods long. Thus, it requires $\Delta z \gg$ grating period [3, 4].

Secondly, we used OptSim 5.0 simulation program to simulate high speed dense WDM communication systems. This simulation program uses method of calculation that is based on solving a complex set of differential equations, taking into account optical and electrical noise, linear and nonlinear effects. Two ways of calculation are possible: Frequency Domain Split Step (FDSS) and Time Domain Split Step (TDSS) methods. These methods differ in linear operator L calculations: FDSS does it in frequency domain, but TDSS calculates linear operator in the time domain by calculating the convolution product in sampled time. The first method is easy to realize, but it may cause severe errors during simulation. In our simulation we used the second method, TDSS, which despite its complexity grants a precise result. The Split Step method is used in all commercial simulation tools to perform the integration of the fiber propagation equation:

$$\frac{\partial A(t, z)}{\partial z} = \{L + N\}A(t, z), \quad (3)$$

where $A(t, z)$ – the optical field; L – linear operator that stands for dispersion and other linear effects; N – operator that is responsible for all nonlinear effects. The idea is to calculate the equation over small spans of fiber Δz by including either linear or nonlinear operator. For instance, on the first span Δz only linear effects are considered, on the second – only nonlinear, on the third – again only linear [5]. As we noticed before, in research are used two simulation programs: BGFS 2.6 – to realize FBG filters amplitude and phase responses and OptSim 5.0 to numerically evaluate high speed dense WDM communication systems. Realized FBG filter parameters were recorded in data file, which after simple mathematical calculations were used in OptSim 5.0 simulation program to build user defined optical filters.

Simulation scheme and parameters

Simulation scheme consists of four channels, which is chosen to evaluate influence of nonlinear optical effects (NOE): self – phase modulation (SPM), cross – phase modulation (XPM), four – wave – mixing (FWM) to used optical filters performance.

The transmitter consists of (see Fig.2.) data source, NRZ driver, continuous wavelength laser source and external Mach-Zehnder modulator. The data source produces a 2.5 Gbit/s or 10.52 Gbit/s bit stream, which represents the information we want to transmit via optical fiber. Then we use a driver to form NRZ pulses from incoming information bits. The pulses are then modulated

with continuous wavelength laser irradiance in Mach-Zehnder modulator to obtain optical pulses. Then formed optical pulses are sent directly to a 40 km long standard single mode fiber (SSMF). The utilized fiber has a large core effective area $80 \mu\text{m}^2$, attenuation $\alpha = 0.2 \text{ dB/km}$, nonlinear refractive coefficient $n_k = 2.5 \cdot 10^{-20} \text{ cm/W}$ and dispersion 16 ps/nm/km at the reference wavelength $\lambda = 1550 \text{ nm}$ [5]. Receiver block consists of PIN photodiode (typical sensitivity -17 dBm) and Bessel – Thomson electrical filter (4 poles, 7.5 GHz -3dB bandwidth). To simulate insertion loss (polarization dependent loss: 0.1 dB, ripple insertion loss: 0.2 dB, splice and connector loss: 0.1dB) of optical filter we used optical attenuator.

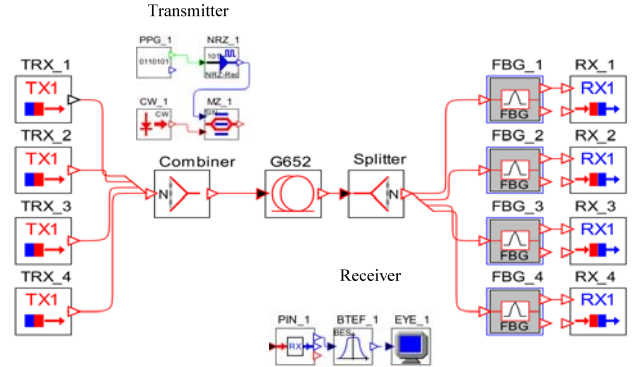

Fig. 2. Four channel simulation scheme with NRZ coding and variable transmission speed 2.5 Gbit/s and 10.52 Gbit/s

Parameters for simulation scheme are chosen based on experimental two channel scheme which is realized in our Fiber Optics Communication Systems Laboratory. Simulation scheme and measurement results were equal so applied numerical results in this paper are actual.

Results and discussions

The main idea of our simulations is to demonstrate FBG filters with different apodization profiles influence on high speed dense WDM communication systems. Investigation of high performance optical band-pass filters are groundwork for realization of high speed dense WDM communication systems.

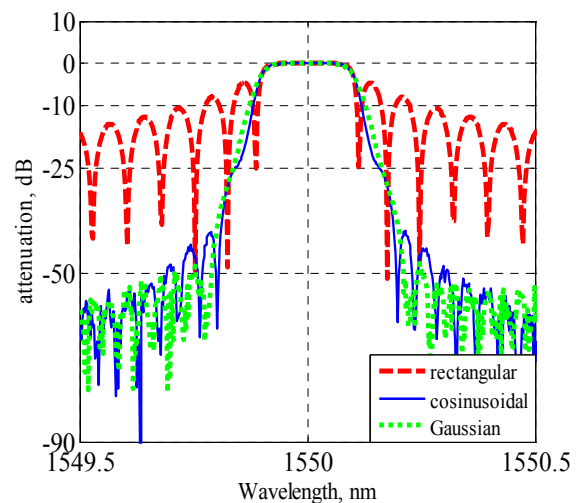

Fig. 3. Amplitude response of 25 GHz FBG optical filters with different apodization profiles shown in inset

The main problem is to ensure high channel isolation between adjacent channels. To realize channel isolation performance evaluation of FBG optical filter we used eye diagram, bit error rate (BER) and optical signal spectrum in different system configurations (different channel spacing and data transmission speed). We have chosen three different apodization profiles (see Fig.3.): rectangular, cosinusoidal and Gaussian, four channel spacing values: 200 GHz, 100 GHz, 50 GHz and 25 GHz (25 GHz channel spacing is not included in ITU standard to date) and two data transmission speeds: 2.5 Gbit/s and 10.52 Gbit/s. In combination of all these parameters we have simulated 24 different WDM communication systems.

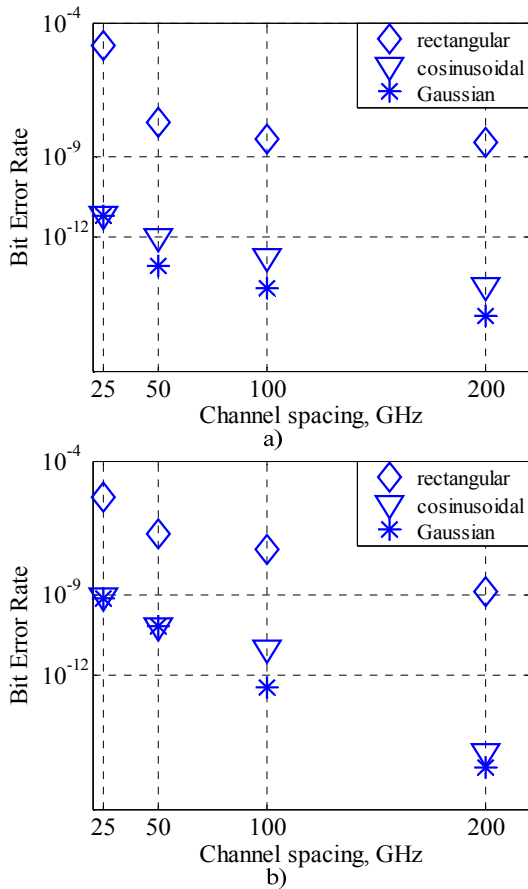

Fig. 4. BER dependence on channel spacing using FBG with rectangular, cosinusoidal and Gaussian apodization profiles: a – 2.5 Gbit/s; b – 10.52 Gbit/s data transmission speed. BER values measured at the worst channel

The results of BER dependence on channel spacing using FBG with rectangular, cosinusoidal and Gaussian apodization profiles are presented in Fig. 4. As we can see systems with 2.5 Gbit/s data transmission speed performance are better (BER values are lower) than systems with 10.52 Gbit/s data transmission speed. This can be explained by greater influence of chromatic dispersion on higher data transmission speed optical pulses. In addition, from results we can see that BER values are higher at 25 GHz channel spacing because of greater NOE influence and 25 GHz FBG filters greater delay, which also influence optical signal detection. At both data transmission speeds and all channel spacing

values, the worst performance showed the 200 GHz, 100 GHz, 50 GHz and 25 GHz FBG optical filters with rectangular apodization profile. This is mainly because of great undesirable side lobes in optical filter amplitude response. These imperfections in filter amplitude response reduced channel isolation. Adjacent channel had high optical power (see Fig.5.) after optical filter and this factor consequently resulted in system degradation (BER level was higher than $1.0E-9$).

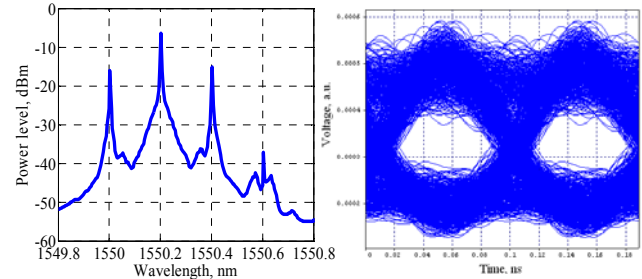

Fig. 5. 10.52 Gbit/s 25 GHz 4 channel WDM system spectrum after 25 GHz FBG filter with rectangular apodization profile and the second channel eye diagram (BER = $4.95E-5$)

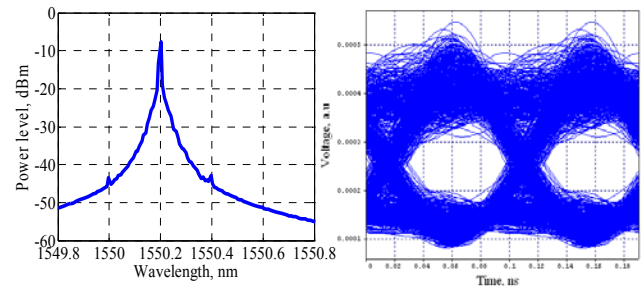

Fig. 6. 10.52 Gbit/s 25 GHz 4 channel WDM system spectrum after 25 GHz FBG filter with Gaussian apodization profile and the second channel eye diagram (BER = $5.63E-10$)

Fig. 6 depicts output that, FBG with Gaussian apodization profile impart high adjacent channel isolation and result in appropriate BER values for high speed dense WDM system, although 25 GHz and 50 GHz optical filters with cosinusoidal apodization function at higher data transmission rate (10.52 Gbit/s) showed the same performance (see Fig.4.B).

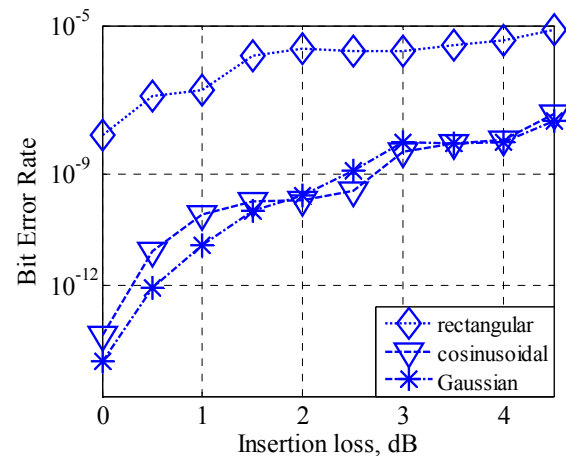

Fig. 7. BER dependence on insertion loss using 25 GHz FBG filters with rectangular, cosinusoidal and Gaussian apodization profiles, 2.5 Gbit/s data transmission speed and channel spacing 25 GHz. BER values measured at the worst channel

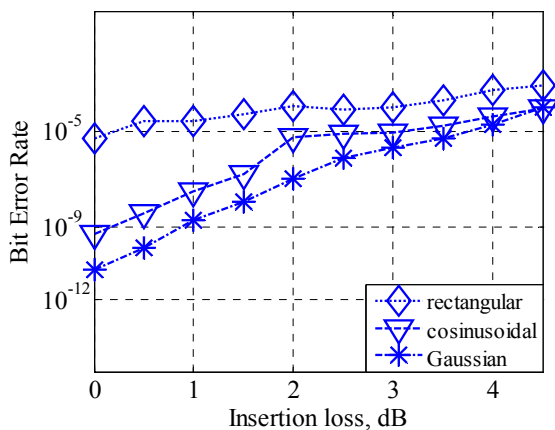

Fig. 8. BER dependence on insertion loss using 25 GHz FBG filters with rectangular, cosinusoidal and Gaussian apodization profiles, 10.52 Gbit/s data transmission speed and channel spacing 25 GHz. BER values measured at the worst channel

As we can see from Fig. 7 and Fig. 8, dense WDM systems are highly sensible on insertion loss of optical filter. Similarly as in previous figure, FBG filter with rectangular apodization profile showed the worst performance. In 2.5 Gbit/s system case FBG filters with cosinusoidal and Gaussian apodization profiles showed a higher stability to insertion loss, whereas in 10.52 Gbit/s systems case only the FBG filter with Gaussian apodization function was the best.

Conclusions

As we could see from simulation results the influence of FBG filters with different apodization profiles on high speed dense WDM communication systems is enormous. To ensure high channel isolation and thus realize systems high performance we need to use FBG filter with

cosinusoidal or Gaussian apodization function (narrow bandwidth at -20 dB level). FBG with rectangular apodization profile showed the worst performance which resulted in whole system degradation because of imperfections (great side lobes) in amplitude response.

Realization of low insertion loss optical filter is a core problem for realization of high speed dense WDM systems. As we could see from the numerical results, filter with Gaussian apodization profile had best stability to insertion loss. We have numerically realized 10.52 Gbit/s data transmission speed 25 GHz channel spacing WDM communication system with 25 GHz FBG optical filters with cosinusoidal and Gaussian apodization profiles utilizing two different simulation programs.

This work has been partly supported by the European Social Fund within the National Program "Support for the carrying out doctoral study program's and post-doctoral researches" project "Support for the development of doctoral studies at Riga Technical University".

References

1. **Agrawal G.** Nonlinear Fiber Optics (Third Edition). //Academic Press. – 2001.
2. **Pfennigbauer M., Winzer P. J.** Choice of MUX/DEMUX filter characteristics for NRZ, RZ, and CSRZ DWDM systems // Lightwave Technology. – 2006. –No. 24(4), -P. 1689 – 1696
3. **Phing H.S., Ali J., Rahman R.A. and Tahir B.A.** Fiber Bragg grating modeling, simulation and characteristics with different grating lengths // Journal of Fundamental Sciences. – 2007. – No.3. – P. 167-175
4. **Kashyap R.** Fiber Bragg grating // Academic Press. – 1999.
5. **Bobrovs V., Ivanovs G.** Parameter Evaluation of a Dense Optical Network // Electronics and Electrical Engineering. – 2006. – No.4 (25). – P. 33-37.

Received 2009 02 15

O. Ozoliņš, Ģ. Ivanovs. Realization of Optimal FBG Band-Pass Filters for High Speed HDWDM // *Electronics and Electrical Engineering*. – Kaunas: *Technologija*, 2009. – No. 4(92). – P. 41–44.

The influence on FBG filters with different apodization profiles on WDM systems is evaluated numerically with OptSim 5.0 and FBGS 2.6 simulation programs at data transmission rate of 2.5 Gbit/s and 10.52 Gbit/s using 40 km of optical fiber. The realization of low insertion loss optical filter is one of key elements to ensure high speed dense WDM system and FBG filter with different apodization profiles influence on high speed dense WDM is enormous. Il. 8, bibl. 5 (in English; summaries in English, Russian and Lithuanian).

O. Ozoliņš, Ģ. Ivanovs. Реализация оптимального FBG полосового фильтра для высокоскоростного HDWDM // *Электроника и электротехника*. – Каунас: *Технология*, 2009. – № 4(92). – С. 41–44.

Численно оценивается влияние FBG фильтров с различными профилями аподизации на системы спектрального уплотнения используя программы моделирования OptSim 5.0 и FBGS 2.6 на скоростях передачи данных 2,5 Гбит/с и 10.52 Гбит/с с использованием 40 км оптического волокна. Реализация оптических фильтров с низкими вносимыми потерями является одним из ключевых элементов для реализации высоко скоростных HDWDM и влияние FBG фильтра с разными профилями аподизации на высоко скоростных HDWDM огромна. Ил. 8, библи. 5 (на английском языке; рефераты на английском, русском и литовском яз.).

O. Ozoliņš, Ģ. Ivanovs. FBG filtrų poveikio HDWDM sistemose tyrimas // *Elektronika ir elektrotechnika*. – Kaunas: *Technologija*, 2009. – Nr. 4(92). – P. 41–44.

Atliktas FBG filtrų su skirtingais apodizacijos profiliais poveikio modeliavimas WDM sistemose taikant programas OptSim 5.0 ir FBGS 2.6. Modeliavimas atliktas esant duomenų perdavimo greičiui 2,5 GB/s bei 10,52 Gbit/s ir optinio pluošto ilgiui 40 km. Pagrindinis elementas, užtikrinantis srauto tankumą WDM sistemose ir FBG filtruose su skirtingais apodizacijos profiliais, yra mažų nuostolių optinis filtras. Nustatyta apodizacijos įtaka srauto tankiui WDM sistemose. Il. 8, bibl. 5 (anglų kalba; santraukos anglų, rusų ir lietuvių k.).

DOI: 10.5755/j02.eie.10224