

## QoS Analysis of IMS Signalling in UMTS Networks

V. Vosylius, D. Pauliukas

Department of Telecommunications, Kaunas University of Technology,

Studentų str. 50-453, LT-51368 Kaunas, Lithuania, e-mail: valdas.vosylius@tk.ktu.lt

### Introduction

The 3rd Generation Partnership Project (3GPP) in standard release 5 (3GPP R5) introduced IP Multimedia Subsystem (IMS) with IETF's protocol Session Initiation Protocol (SIP) for signalling. It is very important to investigate the performance of IMS network nodes and to find out the influence to quality of service (QoS) providing services for users which will be using 3rd generation mobile networks or beyond.

3GPP R5 networks are expected to bring noticeable increase of signalling loads and thus correspond to higher prices of the core network processing nodes infrastructure. SIP based IMS registration signalling calculations are presented in [1], however, it does not cover full signalling load of the IMS infrastructure. Signalling loads for 3GPP R99 and R5 are compared in [2] and a good example of calculations using hit count on each node of the signalling network is presented in [3]. The main focus here is on comparison between two different 3GPP releases and signalling loads roaming between them.

Our goal of this paper is to do research on signalling influence of IMS subsystem when service calls are established. We propose analytical model based on M/D/1 queue where arrivals are characterized as Poisson process and service times are constant (determined).

### The IMS and SIP signalling

IMS provides multimedia services utilizing the SIP protocol. Fig. 1 illustrates simplified UMTS network architecture; for details reader is referred to 3GPP documents [4]. Our work concentrates on IMS signalling research, so UMTS network nodes are not described in details here. Users with devices (User Equipment - UE) connect through UMTS radio access network (UTRAN) to the General Packet Radio Service (GPRS) in core network and activates Packet Data Protocol (PDP) context. The PDP context must be activated at UE before it can access the IMS network. The GPRS core network connects to IMS network through gateway support node (GGSN). The Home Subscriber Server (HSS) serves as master database for both networks (IMS and GPRS) and stores user related

information for mobility, session and services management [4]. Activation of PDP context is not a part of IMS signalling, so it is omitted from our research here. The Media Gateway (MGW) is used by the IMS for user data transportation, no SIP signalling needed at this point.

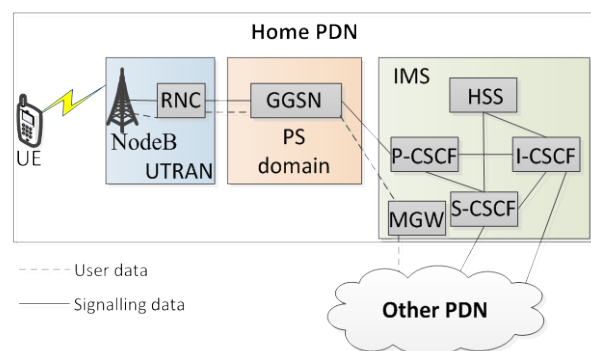

Fig. 1. Simplified UMTS network architecture to provide services over IMS

The IMS CSCF node decomposed to four different nodes that will be described in more details. The first user's contact point into the IMS is Proxy Call Session Control Function (P-CSCF). The P-CSCF acts like a SIP proxy and takes care of these procedures [4]: a) forward SIP request/response to the UE, b) generates SIP transaction logs, c) forward of SIP messages from the UE to SIP server (e.g. S-CSCF) whose name the P-CSCF has received during registration procedure, d) provides authorization of bearer resources and QoS management, e) SIP register request forward from the UE to an I-CSCF determined using the home domain name which was received from the UE.

Interrogating-CSCF (I-CSCF) is the contact point at operator's network for users from that network or roamed users which are using services and are located within network operator's service area. Here are the main functions of I-CSCF [4]: a) the S-CSCF assignment for users which are performing SIP registration procedures, b) interrogates the HSS node during UE initiated session set-up to get the address of the S-CSCF and forwards the SIP request/respond messages to it. In some cases operators may want to hide network topology from other operators.

In such cases they use a Topology Hiding Inter-network Gateway (THIG) in the I-CSCF and SIP requests/responds are forwarded to other I-CSCF (THIG) nodes which allow operators to maintain configuration independently. We do not evaluate THIG in this paper.

Main functions of the S-CSCF are: a) acceptance of registration requests from UE (signalling with HSS needed), b) provides controlling procedures for registered UE sessions, it means that UE's capabilities is not limited and may vary (we do not evaluate this option here), c) interacts with application platforms for different services, also with service event registration platforms, as billing services etc., d) performs acceptance of service requests, forwards these requests further if needed, e) performs termination or generation of SIP transactions.

Home Subscriber Server (HSS) is the central database which stores user related information. Some of the HSS node's functions are: a) user authentication and authorisation control, b) user profile information for available services, billing information, network access etc.

Pre-setup procedures like GPRS attach, PDP context activation and CSCF discovery are used when UE is powered on and has to establish connection with the network. These procedures are not SIP procedures and are not evaluated in our research.

Service Registration procedure is mandatory every time UE requests IMS services [1]. For brevity, we analyse basic service registration procedures (Fig. 2).

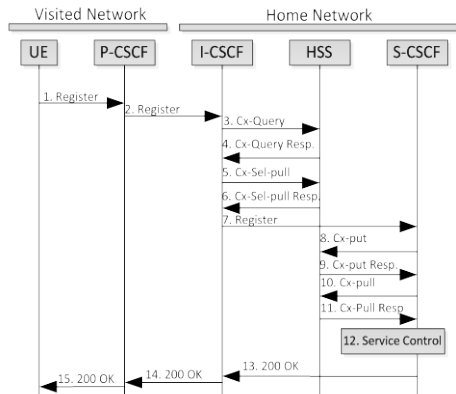

Fig. 2. Service registration procedures [4]

Here are the steps: 1) The UE sends REGISTER to the P-CSCF with its identity information. 2) P-CSCF examines request and sends to appropriate I-CSCF with all needed information. 3-6) I-CSCF then exchange user related and session related information with the HSS node. 7) I-CSCF sends request to the S-CSCF with all addressing, identifying and network information needed for session establishment. 8-12) S-CSCF and HSS nodes exchange information about the user for particular session. Steps from 13 to 15 are response OK messages which confirm about successful procedure set-up. Need to mention that this is just basic registration procedure; other sources may provide more complex solutions with authorization protocols etc. We can conclude that during registration procedure node P-CSCF is hit 2 times, the I-CSCF is hit 4 times, the HSS – 4 times and the S-CSCF is hit 3 times when user resides in its home network and

performing a media session with the user from the same network. Other SIP session flow procedures are not detailed here.

### Analytical model of QoS in IMS signalling

Four common call scenarios are chosen for our investigation. In scenario 1, non roaming subscriber from the home network initiates a call to subscriber from the same network. In other words, originating subscriber and terminating subscriber both are from the same network. Hit count to the IMS nodes for such session is presented in table 1. In scenario 2, originating subscriber from home network is initiating call session to subscriber from other network who is currently visiting (roaming to) first subscriber's network. For the third scenario, originating subscriber from home network is calling to the subscriber from the same network but currently terminating subscriber is roaming to other network. In the fourth scenario, subscriber from the home network is initiating call to subscriber from the other network, both users are not roaming. For all these scenarios we did calculations for hits to each IMS nodes of SIP session flow messages and results are presented in table 1.

Table 1. SIP signaling requests hits ( $k_{ij}$ , where  $i$  – scenario,  $j$  – node) on IMS nodes per different call scenarios

Scenario Node	Scenario 1	Scenario 2	Scenario 3	Scenario 4
1) P-CSCF	24	24	11	13
2) S-CSCF	25	11	25	14
3) I-CSCF	16	4	16	4
4) HSS	4	4	5	4
Total hits of IMS signaling	69	43	57	35

Overall amount of signaling requests hits on all IMS nodes per specific scenario call setup can be expressed by formula

$$k_{IMS_i} = \sum_{n=1}^j k_{ij} . \quad (1)$$

Because of signaling message structure we assume that the mean service times of each IMS node are equal

$$\bar{T}_{P-CSCF} = \bar{T}_{S-CSCF} = \bar{T}_{I-CSCF} = \bar{T}_{HSS} = \bar{T}_{serv} , \quad (2)$$

where  $\bar{T}_{P-CSCF}$  – mean service time of P-CSCF;  $\bar{T}_{S-CSCF}$  – mean service time of S-CSCF;  $\bar{T}_{I-CSCF}$  – mean service time of I-CSCF;  $\bar{T}_{HSS}$  – mean service time of HSS;  $\bar{T}_{serv}$  – common mean service time of IMS system node. Therefore we can build an analytical model based on M/D/1 system and can evaluate the service time

$$\bar{T}_{serv} = 1/\mu_{IMS} , \quad (3)$$

where  $\mu_{IMS} = 2500$  [req./s] – signaling request processing intensity [5]. Following main system parameters follow from the M/D/1 system [6–8] and are adapted to our analytical model:

$$\rho_{IMS} = \lambda_{IMS} / \mu_{IMS}, \quad (4)$$

where  $\rho_{IMS}$  – IMS system utilization rate;  $\lambda_{IMS}$  – signaling packet arrival rate to whole IMS system.

The mean value ( $\bar{W}_{IMS}$ ) of signaling request waiting time in the queue

$$\bar{W}_{IMS} = \frac{\rho_{IMS}}{2\mu_{IMS}(1-\rho_{IMS})}. \quad (5)$$

The mean value ( $\bar{T}_{syst}$ ) of signaling request waiting time in whole IMS system

$$\bar{T}_{syst} = \bar{T}_{serv} + \bar{W}_{IMS} = \frac{2 - \rho_{IMS}}{2\mu_{IMS}(1 - \rho_{IMS})}. \quad (6)$$

From the (6) formula we can find signaling packet arrival rate to all IMS system nodes

$$\lambda_{IMS} = -\frac{\mu_{IMS} - \bar{T}_{syst} \cdot \mu_{IMS}^2}{\bar{T}_{syst} \cdot \mu_{IMS} - \frac{1}{2}}. \quad (7)$$

This dimension will not depend on the used scenario. The difference will be in the arrival rates of calls and signaling requests to separate IMS nodes. That will depend on each scenario ( $\lambda_{calls_i}$  – calls arrival rate to IMS system)

$$\lambda_{calls_i} = \frac{\lambda_{IMS}}{k_{IMS_i}} = -\frac{\mu_{IMS} - \bar{T}_{syst} \cdot \mu_{IMS}^2}{\left(\bar{T}_{syst} \cdot \mu_{IMS} - \frac{1}{2}\right)k_{IMS_i}}. \quad (8)$$

The signaling requests arrival rate ( $\lambda_{ij}$ ) to separate IMS nodes

$$\lambda_{ij} = \frac{\lambda_{IMS} \cdot k_{ij}}{k_{IMS_i}} = -\frac{\left(\mu_{IMS} - \bar{T}_{syst} \cdot \mu_{IMS}^2\right)k_{ij}}{\left(\bar{T}_{syst} \cdot \mu_{IMS} - \frac{1}{2}\right)k_{IMS_i}}. \quad (9)$$

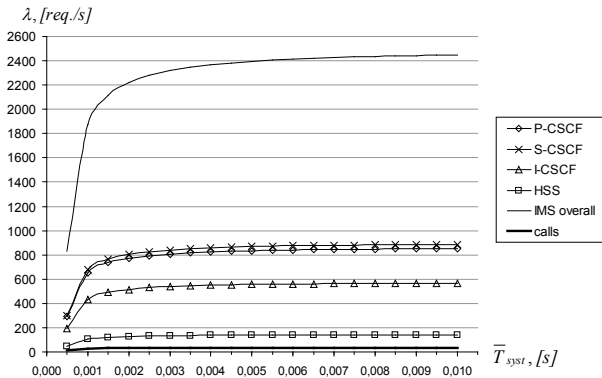

**Fig. 3.** Possible max. amounts of processed signaling requests by IMS nodes and successfully handled call setup procedures dependence on allowed average total system delay in scenario 1

From calculation results we conclude that node S-CSCF has the most influence to the signaling delay in all scenarios, especially for the scenario 3 (refer Fig. 3 and Fig. 5). S-CSCF of the IMS becomes the bottleneck for all

the system the mobile network for known QoS parameters, in our case – total delay of IMS system for processing call session queries in all scenarios examined in this paper. Other node – P-CSCF has significant influence in those scenarios where are users from networks roaming to analyzed network (visiting users). In such case, operator should consider for load balancing solutions of P-CSCF nodes (refer Fig. 4). Other nodes, like I-CSCF and HSS are not so loaded in scenarios with visiting subscribers (refer Fig. 4 and Fig. 6).

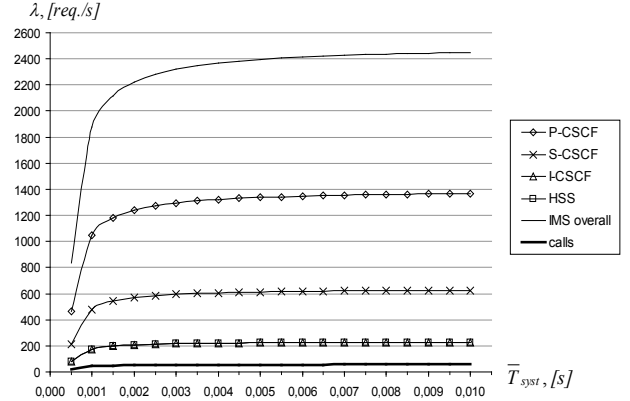

**Fig. 4.** Possible max. amounts of processed signaling requests by IMS nodes and successfully handled call setup procedures dependence on allowed average total system delay on scenario 2

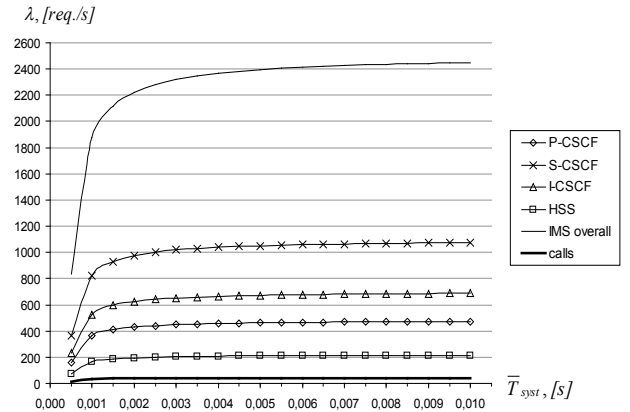

**Fig. 5.** Possible max. amounts of processed signaling requests by IMS nodes and successfully handled call setup procedures dependence on allowed average total system delay on scenario 3

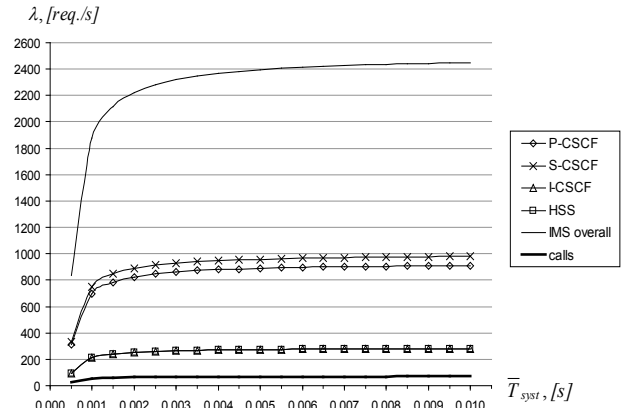

**Fig. 6.** Possible max. amounts of processed signaling requests by IMS nodes and successfully handled call setup procedures dependence on allowed average total system delay on scenario 4

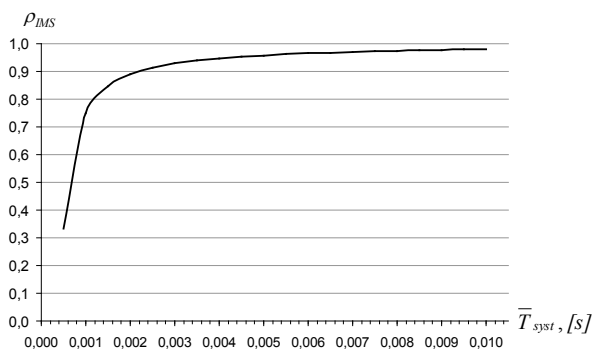

**Fig. 7.** IMS system utilization rate dependence on allowed average total system delay

## Conclusions

We calculated delay caused by the IMS to the whole UMTS network using M/D/1 analytical model. We found that the S-CSCF influenced the IMS performance the most.

Impact of other nodes is highly related with network subscribers and their calling habits. If a lot of users are roaming from other networks, operator should evaluate the node's P-CSCF capabilities.

From the Fig. 7 we can conclude that high utilization level of the IMS subsystem causes high signalling delays. Therefore we would recommend keeping the utilization rate at 0,9 or less and that would cause delays about 5 times lower than for full system utilization.

The biggest amount of possible call setup procedures (from one UMTS operator's point of view) is possible when home user is calling to subscriber of different

network. This amount decreases almost twice when call setup is made between the same network home users.

## References

1. **Munir A.** Analysis of SIP-Based IMS Session Establishment Signalling for WiMax-3G Networks // Proceedings ICNS 2008. – Gosier, Guadeloupe, 2008. – P. 282–287.
2. **Tonesi D. S., Sun Y., Salgarelli L., La Forta T. F.** Evaluation of Signalling Loads in 3GPP Networks // IEEE Wireless Communications. – IEEE, 2008. – No. 15(1). – P. 92–100.
3. **Narbutaite L., Dekeris B.** Triple Play Services Packet Scheduling Performance Evaluation // Electronics and Electrical Engineering. – Kaunas: Technologija, 2008. – No. 6(86). – P. 85–88.
4. **Sauter M.** Beyond 3G: Bringing Networks, Terminals and the Web Together. – Wiley, 2009. – 354 p.
5. **Banerjee N., Wu W., Basu K., Das S. K.** Analysis of SIP-Based Mobility Management in 4G Wireless Networks // Elsevier Computer Communications, 2004. – No. 27(8). – P. 697–707.
6. **Pranevicius H., Paulauskaite-Taraseviciene A., Jarutis A.** Simulation of Protocol for Initiation of Communication Sessions using dynPLA Model // Electronics and Electrical Engineering. – Kaunas: Technologija, 2010. – No. 5(101). – P. 35–38.
7. **Rindzevičius R.** Teletrafiko teorija. – Kaunas: Technologija, 2004. – 248 p.
8. **Paulikas Š.** Estimation of Degraded Video Quality of Mobile H.264/AVC Video Streaming // Electronics and Electrical Engineering. – Kaunas: Technologija, 2010. – No. 2(98). – P. 49–52.

Received 2010 02 14

**V. Vosylius, D. Pauliukas. QoS Analysis of IMS Signalling in UMTS Networks // Electronics and Electrical Engineering. – Kaunas: Technologija, 2010. – No. 9(105). – P. 19–22.**

Purpose of the research was to analyze SIP protocols call setup signalization operations in the IP Multimedia Subsystem and to evaluate how it affects quality of service to the UMTS R5 network. For the research we used simplified model of the IMS network and analyzed SIP signalization information flow in IMS nodes. For analysis of signalization traffic we applied queue M/D/1 model. For known total delay of the whole IMS we calculated possible utilization parameter of the whole IMS and its nodes separately when user distribution is also known. Using this method we calculated that S-CSCF node is loaded the most during call setup signalling procedure in IMS. III. 7, bibl. 8, tabl. 1 (in English; abstracts in English and Lithuanian).

**V. Vosylius, D. Pauliukas. IMS signalizacijos QoS tyrimas UMTS tinkluose // Elektronika ir elektrotechnika. – Kaunas: Technologija, 2010. – Nr. 9(105). – P. 19–22.**

Tyrimo tikslas buvo išanalizuoti SIP protokolo signalizacijos operacijas IP multimėdijos posistemėje (IMS) ir nustatyti įtaką UMTS R5 tinklo kokybiniam rodikliams. Tyrimui atlikti naudojamas IMS tinklo modelis ir analizuojama, kaip jame sklinda SIP protokolo signalizacijos informacija. Signalizacijos srautų analizei buvo pasirinktas M/D/1 eilių analizės modelis. Atsižvelgiant į bendrąjį IMS sistemos vėlinimą buvo skaičiuojamas signalizacijos informacijos galimas bendras bei atskirų sistemos mazgų apkrovimas esant skirtingam abonėntų pasiskirstymo analizuojamame tinkle. Nustatyta, jog IMS sistemoje skambučio sesijos sudarymo procedūroje labiausiai yra apkraunamas S-CSCF mazgas. II. 7, bibl. 8, lent. 1 (anglų kalba; santraukos anglų ir lietuvių k.).