

Research of Harmonic Minimization Possibilities in Grid-tied Photovoltaic System

Č. Ramonas

*Department of Control Technology, Kaunas University of Technology,
Studentų str. 48, LT-51367 Kaunas, Lithuania, phone: +370 37 300274, e-mail: ceslovas.ramonas@ktu.lt*

V. Adomavičius

*The Centre of Renewable Energy, Kaunas University of Technology,
Studentų str. 48-329, LT-51367 Kaunas, Lithuania, phone: +370 37 351181; e-mail: vytautas.adomavicius@ktu.lt*

S. Gečys

*Department of Electric Power Systems, Kaunas University of Technology,
Studentų 48, LT-51367 Kaunas, Lithuania; phone: + 370 37 300277, e-mail: steponas.gecys@ktu.lt*

Introduction

Number and cumulative capacity of all scales renewable power systems mostly based on wind and solar energy increases every year with accelerating rates. Only Germany alone already have installed cumulative capacity of almost 10 GW, including around 3.8 GW installed in 2009. Other EU countries show significant grow in 2009 as well: installed Photovoltaic (PV) capacity of Italy per last year made up 730 MW, further follows Czech Republic – 411 MW, Belgium – 292 MW, France – 185 MW, Spain – 180 MW. The leading positions have countries, which enacted strong support mechanisms for the PV systems [1]. PV markets of Greece, Portugal and the UK are showing signs of considerable growth in 2010 and beyond. It can be expected that in future PV technologies in Lithuania will not be marginal in power generation sector as well [2].

Vast majority of the PV systems are connected to the grid over the inverter. In many cases installation of the grid-connected renewable energy systems with inverters in their power conversion chain is related with the objectionable electromagnetic disturbances (EMD), which are being spread in the power grid during the operation of these systems. Therefore the total harmonic distortion (THD) of the grid-connected converters is limited by the standards (EN 50160:2010). Presently majority of the grid-connected inverters available in the market has THD about 3–5 %.

Object of research

Parameters of electricity produced by the renewable energy systems have to meet the requirements of standards. Quality of the power supplied into electric grid is

determined by the parameters defined in the standard IEC 61400-21:2001. One of the parameters regulates maximum harmonic currents (I_h) during continuous operation given as 10-minute average data for each harmonic up to the 50th. The 10-minute mean RMS values of each harmonic of voltage (u_h) have to be less than the allowed limits during 95 % of time per week. Besides, according to this standard the total harmonic distortion (THD) coefficient is used for the evaluation of total voltage distortion rate. The THD have to be determined as follows

$$\text{THD} = \left[\sum_{h=2}^{40} (u_h)^2 \right]^{1/2}; \quad (1)$$

here h is the number of harmonic order; u_h is the comparative amplitude of the h -th harmonic of voltage

$$u_h = \frac{U_h}{U_p}; \quad (2)$$

here U_p is the nominal value of the 1-st voltage harmonic's amplitude; U_h is the amplitude of the h -th voltage harmonic.

Object of the research is to find out dependences of the current and voltage THD in the output of grid-tied inverter as subject of the form of modulation voltage curve. Minimization of the EMD supplied into electric grid by the proposed PV system can be realized on basis of this research.

The ways of harmonics' minimization in the PV system

Two ways of modulation voltage formation are proposed for the presented power conversion system:

- a) to form the modulation voltage of sine voltages of first and third harmonics according this formula

$$u_{\text{mod}} = k_{\text{mod}} \cdot (u_{1m} \sin \omega t + u_{3m} \sin 3\omega t), \quad (3)$$

- b) to form the modulation voltage of sine voltage raised to the power n

$$u_{\text{mod}} = k_p \cdot (u_{1m} \sin \omega t)^n, \quad (4)$$

here u_{1m} is the amplitude of 1-st harmonic; u_{3m} is the amplitude of 3-rd harmonic; k_{mod} is the coefficient of modulation; k_p is the coefficient of matching; n is the index of power.

The form of the modulation voltage curve (non-linearity) in the first case (A case) is varied by changing the third voltage harmonic u_{3m} amplitude value from 0 to 1.0 V. The curves of modulation voltage in this case for the positive half-period have the shapes as it is shown in Fig. 1.

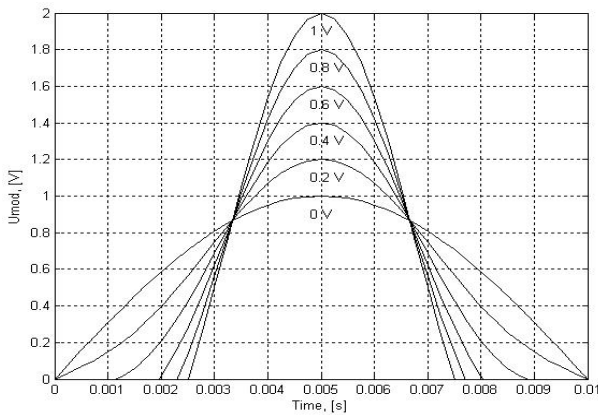

Fig. 1. The curves of modulation voltage formed of sine voltages of first and third harmonics (A case)

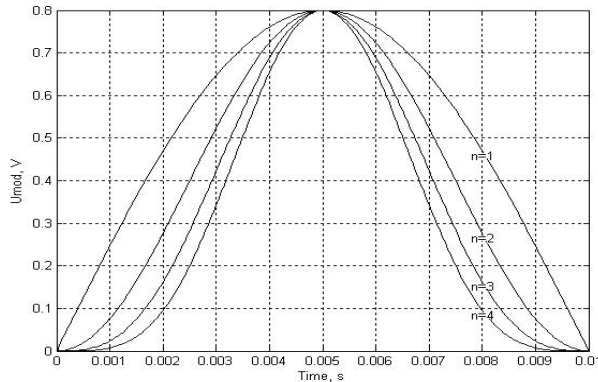

Fig. 2. The curves of modulation voltage when sine voltage is function of degree ($k_p = 0.4$)

Restriction of the modulation voltage negative values is applied in order to receive the forms of the curves as presented in this figure. It can be noticed in Fig. 1 that amplitude of modulation voltage changes. Therefore coefficient of modulation k_{mod} has to be changed simultaneously after the change of voltage u_{3m} on purpose to keep the amplitude of modulation voltage on the necessary constant value. Apart this, Fig. 1 shows that voltage of modulation changes the from sine wave to the periodical non-linear curve with intervals of time having

this voltage equal to zero when u_{3m} varies from 0 to 1. Control pulses of the inverter in these intervals of time will be blocked.

The non-linearity of the modulation voltage curve in the second case (B case) is varied by changing coefficient k_p and index of power n . The modulation voltage curves in this case for the positive half-period have the shapes shown in Fig. 2.

As shows Fig. 2, zero voltage intervals do not exist in the curves of modulation voltages. Further research of transient processes of the PV system's inverted current showed that zero voltage intervals (Fig. 1) have significant negative impact to the form of this curve.

Mathematical model of the researched PV system

The schemes of the power circuits analogous to the analysed PV system are described in the previous papers of authors [3, 4] where mathematical descriptions and mathematical models are presented together with results of research carried out for the current and voltage supplied into electric grid over inverter. In that case purely sine wave modulation voltage was applied in the inverter's control scheme.

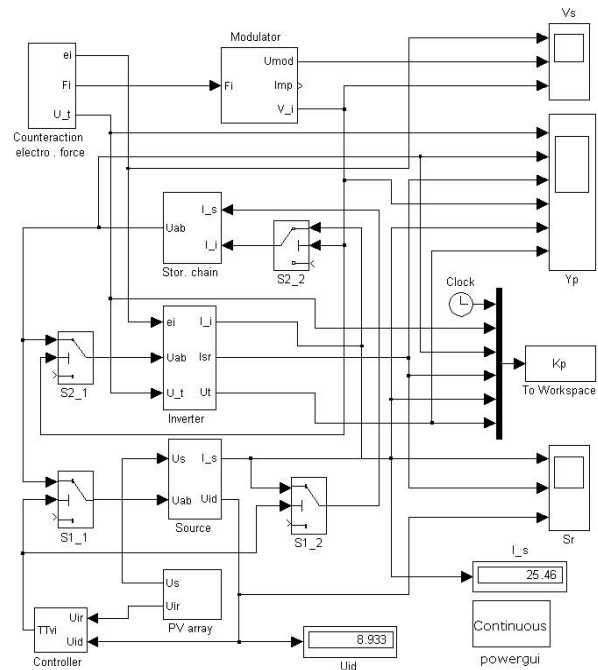

Fig. 3. MATLAB/SIMULINK model of the PV system with alternate modulation unit

A similar system and MATLAB/SIMULINK model are used in this paper (Fig. 3). The main difference between the model presented in [3] and model in this paper is the PV system instead of the WT and scheme of the modulation voltage subunit "Modulator". In this paper in one case it will be the scheme generating modulation curve of the sine voltages of first and third harmonics (Fig. 4) arranged according to the formula (3) and in the next case – the scheme generating modulation curve of the sine voltage involutes in the power n (Fig. 5) arranged according to the formula (4).

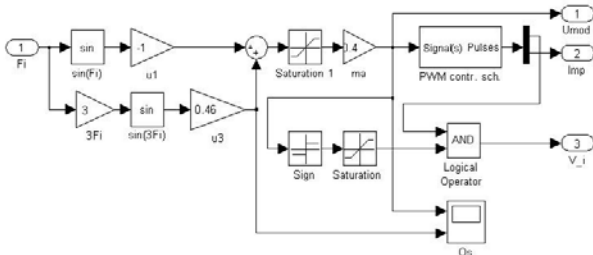

Fig. 4. Scheme of the “Modulator” generating modulation curve of sine voltages of first and third harmonics (case A)

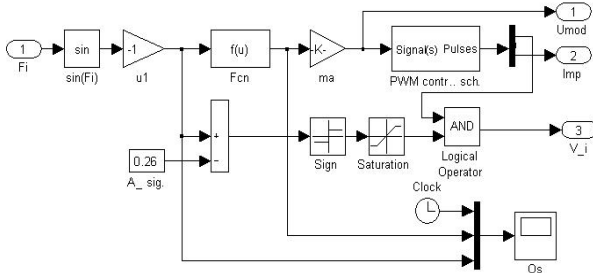

Fig. 5. Scheme of the subunit “Modulator” generating modulation curve of sine voltage involuted in the power n (case B)

Results of the research

Many simulations were performed using the MATLAB/SIMULINK model (Fig. 3) of the PV system with alternate modulation unit on purpose to find out impact of the shape and parameters of the modulation voltage to the THD of the inverted current and voltage. Dependences of the THD of the inverted current and voltage on the amplitude of third voltage harmonic u_{3m} for the case A are shown in Fig. 6. Analogous dependences of the THD of the inverted current and voltage on the index n for the case B are shown in Fig. 7. In both cases the curves of THD of inverted current (1) have evident extreme values of the THD (minimums) at certain varied parameters.

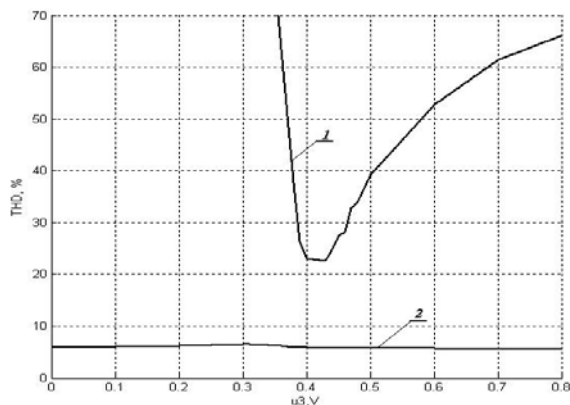

Fig. 6. THD of the inverted current (1) and voltage (2) versus to the amplitude of third voltage harmonic u_{3m} in (case A)

Dependences of the THD of the inverted voltage on the amplitude of third voltage harmonic u_{3m} for the case A and on the index n for the case B (the same Fig. 6 and Fig. 7, curves 2) have a different character. Analysis of these curves allows concluding that THD in this case is not

so sensitive to the shape and parameters of the modulation voltage.

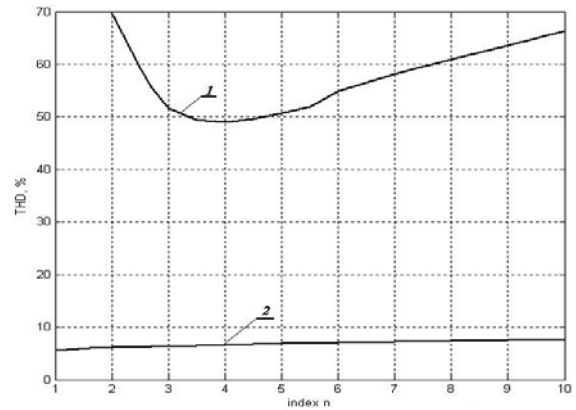

Fig. 7. THD of the inverted current (1) and voltage (2) versus to index n (case B)

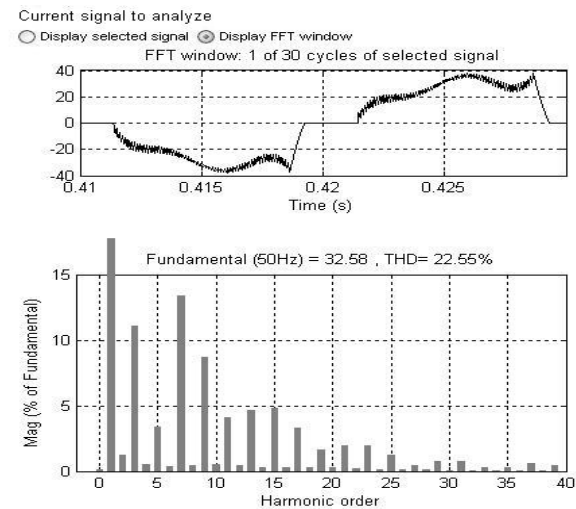

Fig. 8. THD of the inverted current for voltage of third harmonic $u_{3m} = 0.43$ V (case A)

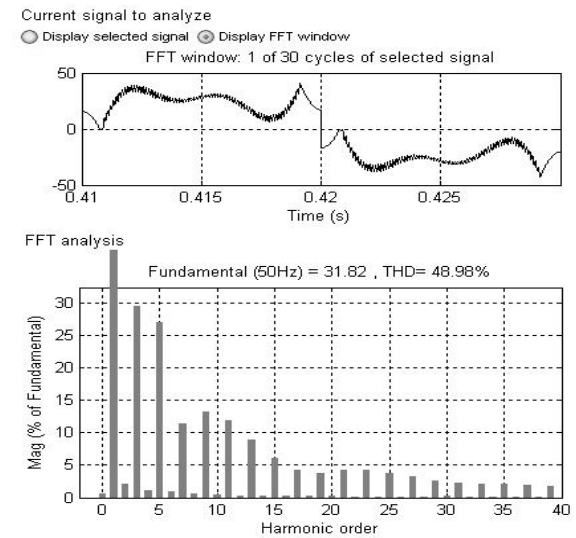

Fig. 9. THD of the inverted current for index $n = 4.5$ (case B)

As it can be determined after the comparison of Fig. 6 and Fig. 7, Fig. 8 and Fig. 9, the modulation voltage curve arranged of sine voltages of first and third harmonics

proved it as giving some twice less THD of the inverted current.

Traditional way for further harmonics' minimization in the researched PV system by means of the filters connected to the output of the system's inverter can be applied.

Other methods for research of deforming in electric grid can be applied too [5]. Minimization of harmonics generated by the PV system is even more important when it is operating within a microgrid of limited capacity [6]. Small renewable power sources can be used for increasing efficiency of power supply in remote rural areas [7].

Conclusions

1. Grid-tied PV installations in the EU countries and worldwide currently are on the skyrocketing increase.

2. Method of harmonics' minimization by means of shape selection of the inverter control unit's modulation voltage curve is presented.

3. Two shapes of the modulation voltage are proposed: the curve of sine voltages of first and third harmonics and the curve of the sine voltage involutes in the n power.

4. Dependences of the THD of the inverted current on the parameters of proposed forms of modulation voltage were determined by means of simulation and in both cases evident extreme values of the THD (minimums) at certain varied parameters were found.

5. According to the results of researches the curve of sine voltages of first and third harmonics proved itself as giving twice less THD of inverted current.

6. THD of the inverted voltage shows that its dependence of the on the form and parameters of modulation voltage is not so sensitive.

7. Further harmonics' minimization in the proposed small scale grid-tied PV system is possible by means of the filters connected to the output of the system's inverter.

References

1. Jäger-Waldau A. PV Status Report 2009. – Joint Research Centre of EC. August 2009. – 118 p.
2. Lietuvos Respublikos Atsinaujinančių išteklių energetikos įstatymas. – Projektas Nr. XIP-1749 (2), 2010. – 63 p.
3. Kepalas V., Ramonas Č., Adomavičius V. Connection of the RES-based power plants into the electric grid // Electronics and Electrical Engineering. – Kaunas: Technologija, 2007. – No. 8(80). – P. 67–72.
4. Ramonas Č., Kepalas V., Adomavičius V. Iš atsinaujinančių šaltinių gautos elektros konversijos procesų tyrimas // Electronics and Electrical Engineering. – Kaunas: Technologija, 2006. – No. 2(66). – P. 78–83.
5. Raž G., Raž M., Filote C., Stugeru C. Theoretical and Experimental Aspects Concerning Fourier and Wavelet Analysis for Deforming Consumers in Power Network // Electronics and Electrical Engineering. – Kaunas: Technologija, 2010. – No. 1(97). – P. 62–66.
6. Yubing D., Yulei G., Qingmin L., Hui W. Modelling and Simulation of the Microsources within a Microgrid // Electrical Machines and Systems (ICEMS 2008). – Jinan, China, 2008. – P. 2667–2671.
7. Kunicina N., Galkina A., Zhiravecka A., Chaiko Y., Ribickis L. Increasing Efficiency of Power Supply System for Small Manufactures in Rural Regions using Renewable Energy Resources // Electronics and Electrical Engineering. – Kaunas: Technologija, 2009. – No. 8(96). – P. 19–22.

Received 2010 10 15

Č. Ramonas, V. Adomavičius, S. Gečys. Research of Harmonic Minimization Possibilities in Grid-tied Photovoltaic System // Electronics and Electrical Engineering. – Kaunas: Technologija, 2010. – No. 1(107). – P. 83–86.

The photovoltaic power systems are becoming important in the power production market with each succeeding year what can be determined by the skyrocketing development of cumulative installed power of the PV installations in the EU countries and worldwide. In this paper results of researches for minimization of the total current and voltage harmonics' distortion of the PV system are presented. Researches were performed by means of MATLAB/SIMULINK programme and "Powerqui" unit. Method for minimization of electromagnetic disturbances generated by the small scale PV system is based on the selection of the proper shape and parameters of the modulation voltage. Two shapes of the modulation voltage are proposed: the curve of sine voltages of first and third harmonics and the curve of the sine voltage involutes in the n power. Dependences of the total harmonic disturbances of the inverted current and voltage on the parameters of proposed forms of modulation voltage were determined by means of simulation. Evident extreme values of the total harmonic disturbances (minimums) at certain varied parameters were found in both cases. According to the results of researches the curve of sine voltages of first and third harmonics proved itself as giving twice less total harmonic disturbances of inverted current. Total harmonic disturbances of the inverted voltage show that its dependence of the on the form and parameters of modulation voltage is not so sensitive. Ill. 9, bibl. 7 (in English; abstracts in English and Lithuanian).

Č. Ramonas, V. Adomavičius, S. Gečys. Harmonikų parametų sumažinimo galimybių tyrimas į elektros tinklą integruotoje saulės elektrinėje // Elektronika ir elektrotechnika. – Kaunas: Technologija, 2010. – Nr. 1(107). – P. 83–86.

Saulės elektrinės kasmet įgyja vis didesnę reikšmę Europos Sąjungos ir viso pasaulio elektros energijos gamybos rinkoje. Tuo galima įsitikinti išanalizavus jų bendrosios įrengtosios galios didėjimo tempus. Šiame straipsnyje pateikti į tinklą integruotos mažos galios saulės elektrinės invertuojamos srovės ir įtampos harmonikų iškreipio faktoriaus minimizavimo galimybių tyrimo rezultatai. Tyrimai buvo atlikti naudojant MATLAB/SIMULINK programą ir „Powerqui“ bloką. Ištirtas elektromagnetinių trikdžių minimizavimo saulės elektrinėje būdas, pagrįstas tinkamos moduliavimo įtampos kreivės formos ir jos parametų parinkimu. Buvo naudotos dvi moduliavimo įtampos formos: kreivė, sudaroma iš pirmosios ir trečiosios harmonikos įtampų, ir kreivė, gaunama sinusinę įtampą pakėlus n laipsniu. Invertuojamos srovės ir įtampos harmonikų iškreipio faktoriaus priklausomybės nuo pasiūlytų moduliavimo įtampos formų buvo ištirtos modeliavimo būdu. Abiem atvejais buvo nustatytos aiškios ekstremalios harmonikų iškreipio faktoriaus vertės (minimumai) esant tam tikroms keičiamų parametų vertėms. Naudojant moduliavimo kreivę, sudaromą iš pirmosios ir trečiosios harmonikų sinusinių įtampų, esant optimaliems jos parametrams galima gauti dvigubai mažesnę invertuojamos srovės harmonikų iškreipio faktorių, palyginti su antrąja moduliavimo kreive. Buvo nustatyta, kad invertuojamos įtampos harmonikų iškreipio faktoriaus nėra toks jautrus moduliavimo įtampos kreivės formai ir jos parametrams. Il. 9, bibl. 7 (anglų kalba; santraukos anglų ir lietuvių k.).