

Investigation of P and PD Controllers' Performance in Control Systems with Steady-State Error Compensation

D. Levisauskas, T. Tekorius

Process Control Department, Kaunas University of Technology,
Studentų str. 50-153, 51368 Kaunas, Lithuania, phone: +370 37 300261, e-mails: donatas.levisauskas@ktu.lt,
tomas.tekorius@ktu.lt

crossref <http://dx.doi.org/10.5755/j01.eee.121.5.1297>

Introduction

A proportional-integral-derivative (PID) controller is the most common controller in industrial process control systems [1]. The three-term control action takes into account the present error (P), accumulation of past errors (I) and prediction of future errors (D), and the weighted sum of these actions depends on the weighting coefficients that are adjusted to the optimum values for the desired response of controlled process. Particular applications require only one (P, I) or two (PI, PD) control actions to provide the required accuracy of control.

Choosing of control law depends on requirements to a control system. One of frequent requirements is absence of steady-state error between the set-point and the controlled output. The steady-state error is an inbuilt characteristic of feed-back control systems with P and PD controllers and the most common way of the error elimination is to add an integral term (I) to the control law. Although the integral term of PI and PID control laws allows automatic elimination of the error, it tends to increase the oscillatory or rolling behavior of the process response. The other disadvantage related to the integral term is an integral windup problem that occurs at large set-point changes and the process saturation [1–3].

The alternative way of the steady-state error elimination is to add an adjustable reset term to the control signal or to add a corrective term to the input of system with P or PD controller. As the above controllers demonstrate better stability properties, application of this approach can be worthwhile.

In this work, we investigate performances of P and PD controllers in the system with steady-state error compensation by adding a corrective term to the system input. The control system responses are evaluated with the integral of time-weighted absolute error (ITAE) [2]. The results are compared with those of ordinary PI and PID control systems. Performance of P controller in the system

with steady-state error compensation and the system adaptation to time-varying operating conditions is investigated via computer simulation of the set-point control system of dissolved oxygen concentration (DOC) in batch operating mode bioreactor.

P and PD control systems with steady-state error compensation

Structure of feed-back P (PD) control system with steady-state error compensation is shown in Fig. 1.

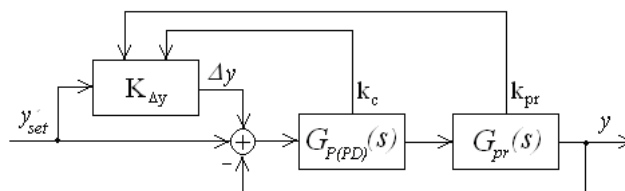

Fig. 1. P (PD) control system with steady-state error compensation

In Fig. 1, $K_{\Delta y}$ is transfer coefficient between the set-point and the corrective term; $G_{pr}(s)$ is transfer function of controlled process; $G_p(s) = k_c$ and $G_{PD}(s) = k_c(1 + T_d s)$ are transfer functions of P and PD controllers, respectively; y and y_{set} are the process output and the set-point, respectively; Δy is corrective term; k_{pr} and k_c are the process and the controller gain coefficients, respectively; T_d is differentiation time constant, s is Laplace operator.

With P or PD controller, at steady-state operating conditions the corrective term Δy at the input of feed-back control system that compensates deviation of process output from the set-point satisfies the condition

$$(y_{set} + \Delta y) \frac{k_c k_{pr}}{1 + k_c k_{pr}} = y_{set} \quad (1)$$

From equation (1) it follows, that the corrective term is related with the set-point value by a relationship

$$\Delta y = K_{\Delta y} y_{set} \quad (2)$$

where

$$K_{\Delta y} = 1 / (k_c k_{pr}) \quad (3)$$

Simulation of the control systems performance

Performances of P and PD control systems with steady-state error compensation and the ordinary PI and PID control systems were investigated via numerical simulation implemented in MATLAB/Simulink environment. In the simulation experiments, the controlled process was modeled by a 3rd order transfer function with time delay

$$G_{pr}(s) = \frac{k_{pr} \exp(-\tau_{pr}s)}{(T_1s+1)(T_2s+1)(T_3s+1)} \quad (4)$$

where k_{pr} is process gain, T_1 , T_2 , T_3 are time constants, and τ_{pr} is time delay.

In the simulations, the gain coefficient was set $k_{pr} = 1$, and several sets of the model parameter T_1 , T_2 , T_3 , τ_{pr} values were used. The variant values of the parameters are given in Table 1.

The P, PD, PI and PID controllers in simulation experiments were tuned for each set of model parameters to minimize the ITAE criterion. The controller parameters were optimized in 2 steps: at the 1st step, the process model (4) was approximated by a first order plus time delay (FOPTD) model and the ITAE criterion tuning rules developed for the FOPTD model [2] were applied to determine the first approach values of the controller parameters; at the 2nd step, the first approach parameter

values were improved using the Quadratic Programming algorithm (function "fmincon") from the MATLAB Optimization Toolbox library.

The ITAE criterion values were calculated for the control system responses to a unit step set-point change. In Fig. 2, the simulation results are presented for the model parameters set No 10 given in Table 1. The step change in set-point has been introduced at time $t = 0$.

Values of the control systems performance criterion (ITAE) calculated for all investigated variants are compared in Fig. 3.

Table 1. Process model parameters used in simulation experiments

Variant No	Model parameters			
	T_1	T_2	T_3	τ_{pr}
1	100	40	10	10
2	50	40	10	10
3	100	20	10	10
4	50	20	10	10
5	100	40	5	10
6	50	40	5	10
7	100	20	5	10
8	50	20	5	10
9	100	40	10	20
10	50	40	10	20
11	100	20	10	20
12	50	20	10	20
13	100	40	5	20
14	50	40	5	20
15	100	20	5	20
16	50	20	5	20

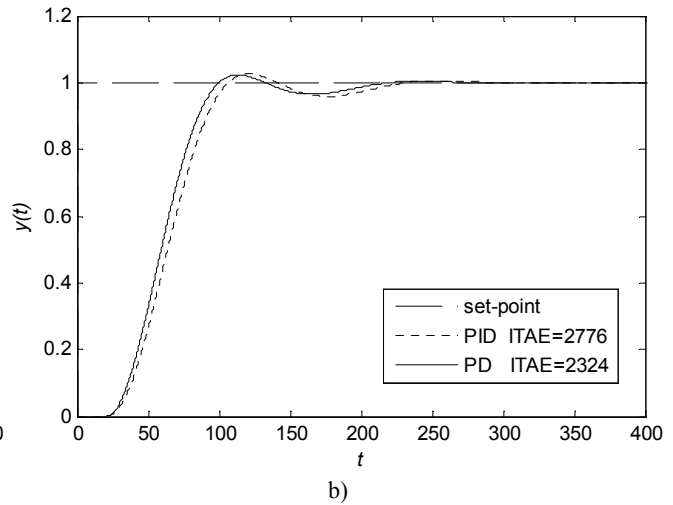
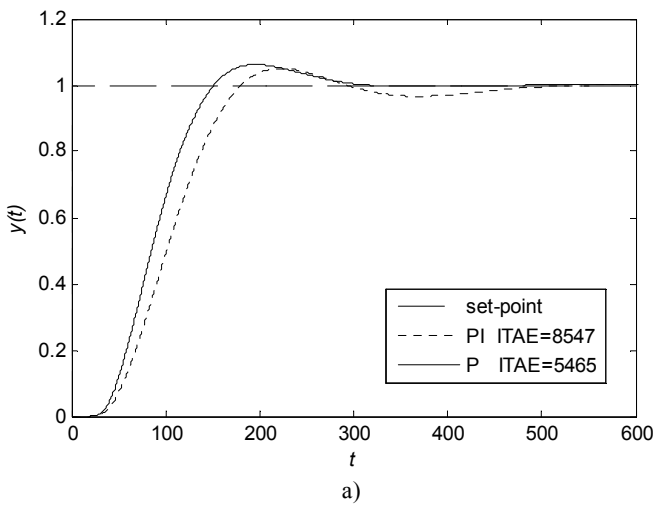

Fig. 2. Simulated responses of the control systems to a unit step set-point change: a – P control system with steady-state error compensation versus ordinary PI control system; b – PD control system with steady-state error compensation versus ordinary PID control system

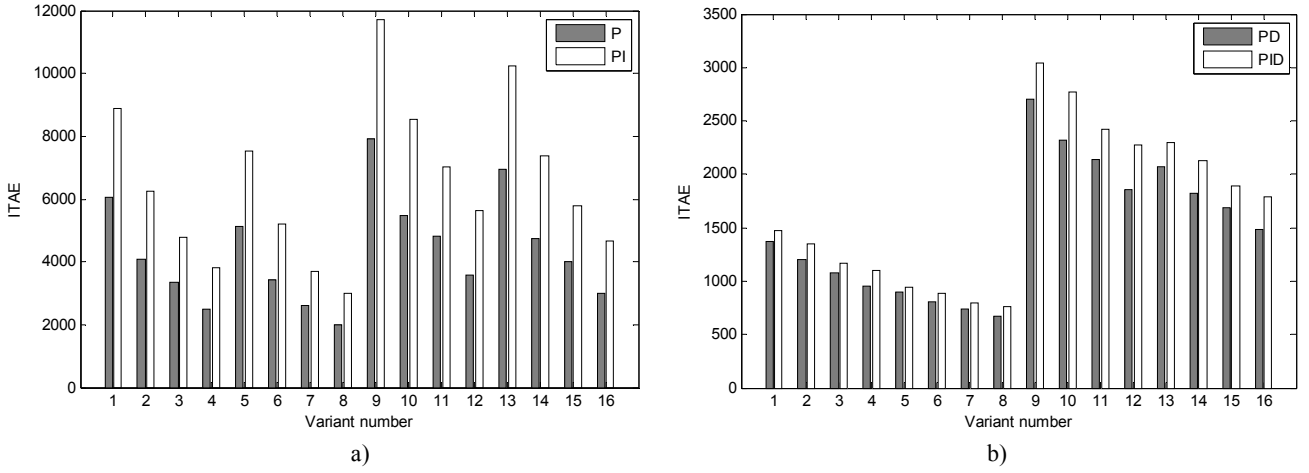

Fig. 3. Comparison of the ITAE criterion values, calculated from the simulation experiments: a – P with steady-state error compensation versus PI; b – PD with steady-state error compensation versus PID

Referring to the evaluated values of the ITAE criterion, we find that the P controller with the steady-state error compensation is about 50% better than the PI controller with respect to mean values (at normalized standard deviation $\sigma = 4.9\%$), and the PD controller is about 13% better than the PID controller ($\sigma = 4.8\%$). Statistical tests on comparison of 2 sample means [4] prove that the observed difference in the ITAE criterion values are significant with a 5 % level of significance.

Simulation of the control systems performance for controlling the dissolved oxygen concentration in bioreactor

Dissolved oxygen concentration (DOC) is an important technological parameter of aerobic fermentation processes that is to be accurately controlled at a particular level. The controlled process is nonlinear and nonstationary, therefore, adaptation of feed-back controller to time-varying operating conditions is required to ensure an accurate set-point control over entire batch fermentation cycle.

One of developed approaches to adaptation of the DOC controller parameters is based on adaptive transfer function that is derived from the process state model and updated on-line with the measured values of process variables [5]. The transfer function parameter values are directly introduced in the controller tuning rules that are used for recalculation the controller parameters at each time discretization step.

In this work, the above controller adaptation technique is applied for adaptation of PI controller in an ordinary feed-back control system and adaptation of P controller and the transfer coefficient between the set-point and the corrective term in the control system with steady-state error compensation.

In the simulation experiments, the controlled process is modeled by a set of equations [5, 6]:

$$\frac{dC}{dt} = \alpha \cdot u^\beta q^\gamma (C_{\text{sat}} - C) - OUR, \quad (5)$$

$$\frac{dC_e}{dt} = \frac{1}{T_e} (k_e C - C_e), \quad (6)$$

where C is DOC, mmol L^{-1} ; C_e is signal of dissolved oxygen (DO) electrode, %; C_{sat} is saturation value of DOC, mmol L^{-1} , $C_{\text{sat}} = 0.21/H$, H is Henry's constant, L mmol^{-1} ; u is stirring speed (control action), s^{-1} ; q is air supply rate, L s^{-1} ; OUR is volumetric oxygen uptake rate, $\text{mmol L}^{-1} \text{s}^{-1}$; t is time, s ; T_e is time constant of DO electrode, s ; k_e is proportionality coefficient, $k_e = 100 \cdot H/0.21$; α , β , γ are model parameters.

The model equation (5) represents mass balance on oxygen in fermentation broth and equation (6) represents first order dynamics of DO electrode. Parameters of the model equations are taken from the ranges reported in [6]: $H = 0.7906$, $\alpha = 0.0015$, $\beta = 2.0$, $\gamma = 0.2$.

In the vicinity of steady-state operating conditions at time point t_k the process dynamics can be represented by linear differential equations derived by linearization of the state equations (5), (6):

$$\frac{d\Delta C}{dt} = -\left[\alpha \cdot u^\beta q^\gamma\right]_{t=t_k} \Delta C + \left[\alpha \beta u^{\beta-1} q^\gamma (C_{\text{sat}} - C)\right]_{t=t_k} \Delta u, \quad (7)$$

$$\frac{d\Delta C_e}{dt} = \frac{1}{T_e} k_e \Delta C - \frac{1}{T_e} \Delta C_e, \quad (8)$$

where ΔC , ΔC_e and Δu are small deviations of C , C_e and u from the process state point at time t_k .

By applying the Laplace transformation to equations (7), (8), the controlled process dynamics can be represented by a 2nd order transfer function:

$$G_{\Delta C_e / \Delta u}(s) = \frac{k_{\Delta C / \Delta u}(t_k) k_e}{\left[T_{\Delta C / \Delta u}(t_k) s + 1\right] (T_e s + 1)}, \quad (9)$$

$$k_{\Delta C/\Delta u}(t_k) = \left[\frac{\beta(C_{set} - C)}{u} \right]_{t=t_k}, \quad (10)$$

$$T_{\Delta C/\Delta u}(t_k) = \left[\frac{1}{\alpha u^\beta q^\gamma} \right]_{t=t_k}. \quad (11)$$

Assuming quasi-steady-state conditions for DOC ($dC/dt \approx 0$), the dynamic parameters $k_{\Delta C/\Delta u}(t_k)$ and $T_{\Delta C/\Delta u}(t_k)$ can be estimated on-line using measured value of $OUR(t_k)$ and set-point value of DOC ($C(t_k) \approx C_{set}(t_k)$):

$$k_{\Delta C/\Delta u}(t_k) = \beta \left\{ \alpha q^\gamma \frac{[100 - C_{set}(t_k)]^{(\beta+1)}}{k_e OUR(t_k)} \right\}^{1/\beta}, \quad (12)$$

$$T_{\Delta C/\Delta u}(t_k) = \frac{100 - C_{set}(t_k)}{k_e OUR(t_k)}. \quad (13)$$

In the adaptive control system, the updated transfer function model (9) is further reduced to a FOPTD model

$$G_{\Delta C_e/\Delta u}^* = \frac{k_{\Delta C_e/\Delta u}(t_k)}{T_{\Delta C_e/\Delta u}(t_k)s+1} \exp[-\tau_{\Delta C_e/\Delta u}(t_k)], \quad (14)$$

where $k_{\Delta C_e/\Delta u} = k_e k_{\Delta C/\Delta u}$, $T_{\Delta C_e/\Delta u}(t_k)$ and $\tau_{\Delta C_e/\Delta u}(t_k)$ are resultant time constant and resultant time delay of the controlled process at time t_k , respectively. The model parameters $T_{\Delta C_e/\Delta u}(t_k)$ and $\tau_{\Delta C_e/\Delta u}(t_k)$ are updated by fitting the FOPTD model (14) at each sampling time to a simulated step response of the model (9) using the Smith's approximation technique [2].

The updated FOPTD model is directly applied for controller parameters on-line adaptation using controller tuning rules developed for simple dynamic models.

The adaptive PI control is implemented by the control system presented in Fig. 4.

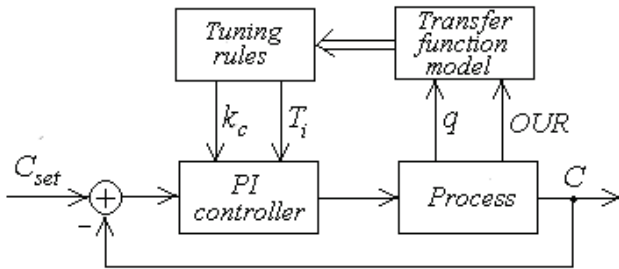

Fig. 4. DOC adaptive control system with PI controller

In the control system (Fig. 4), the velocity form of discrete PI control algorithm is used:

$$u(t_k) = u(t_{k-1}) + \Delta u(t_k), \quad (15)$$

$$\Delta u_k(t_k) = k_c(t_k) \left\{ \left[1 + \frac{\Delta t}{T_i(t_k)} \right] e(t_k) - e(t_{k-1}) \right\}, \quad (16)$$

$$e(t_k) = C_{set}(t_k) - C(t_k). \quad (17)$$

For adaptation of PI controller parameters the Ziegler&Nichols tuning rules [2] are applied:

$$k_c(t_k) = \frac{0.9 T_{\Delta C_e/\Delta u}(t_k)}{k_{\Delta C_e/\Delta u}(t_k) \tau_{\Delta C_e/\Delta u}(t_k)}, \quad (18)$$

$$T_i(t_k) = 3.33 \tau_{\Delta C_e/\Delta u}(t_k). \quad (19)$$

The adaptive P control with steady-state error compensation is implemented by the control system presented in Fig. 5.

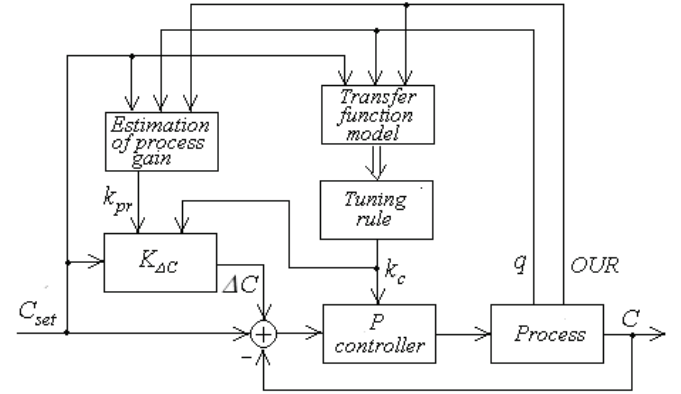

Fig. 5. DOC adaptive control system with P controller and steady-state error compensation

The discrete P control algorithm realized in the control system (Fig. 5) is

$$u_k(t_k) = k_c(t_k) e(t_k), \quad (20)$$

in which adaptation of the controller gain is realized by the Ziegler&Nichols tuning rule [2]

$$k_c(t_k) = \frac{T_{\Delta C_e/\Delta u}(t_k)}{k_{\Delta C_e/\Delta u}(t_k) \tau_{\Delta C_e/\Delta u}(t_k)}. \quad (21)$$

The process gain $k_{pr}(t_k)$ is estimated from the model equation (5) at steady-state conditions ($dC/dt = 0$):

$$\begin{aligned} k_{pr}(t_k) &= \frac{C_{set}(t_k)}{u_{dC/dt=0}(t_k)} = \\ &= C_{set}(t_k) \left\{ \frac{\alpha q^\gamma [100 - C_{set}(t_k)]}{k_e OUR(t_k)} \right\}^{1/\beta}. \end{aligned} \quad (22)$$

The transfer coefficient between the set-point and the corrective term $K_{\Delta C}(t_k)$ is estimated from the calculated values $k_c(t_k)$ and $k_{pr}(t_k)$

$$K_{\Delta C}(t_k) = \frac{1}{k_c(t_k) \cdot k_{pr}(t_k)}. \quad (23)$$

Performances of the control systems, presented in Fig. 4 and Fig. 5, were investigated via computer simulations realized in MATLAB/Simulink environment. The simulation results are shown in Fig. 6.

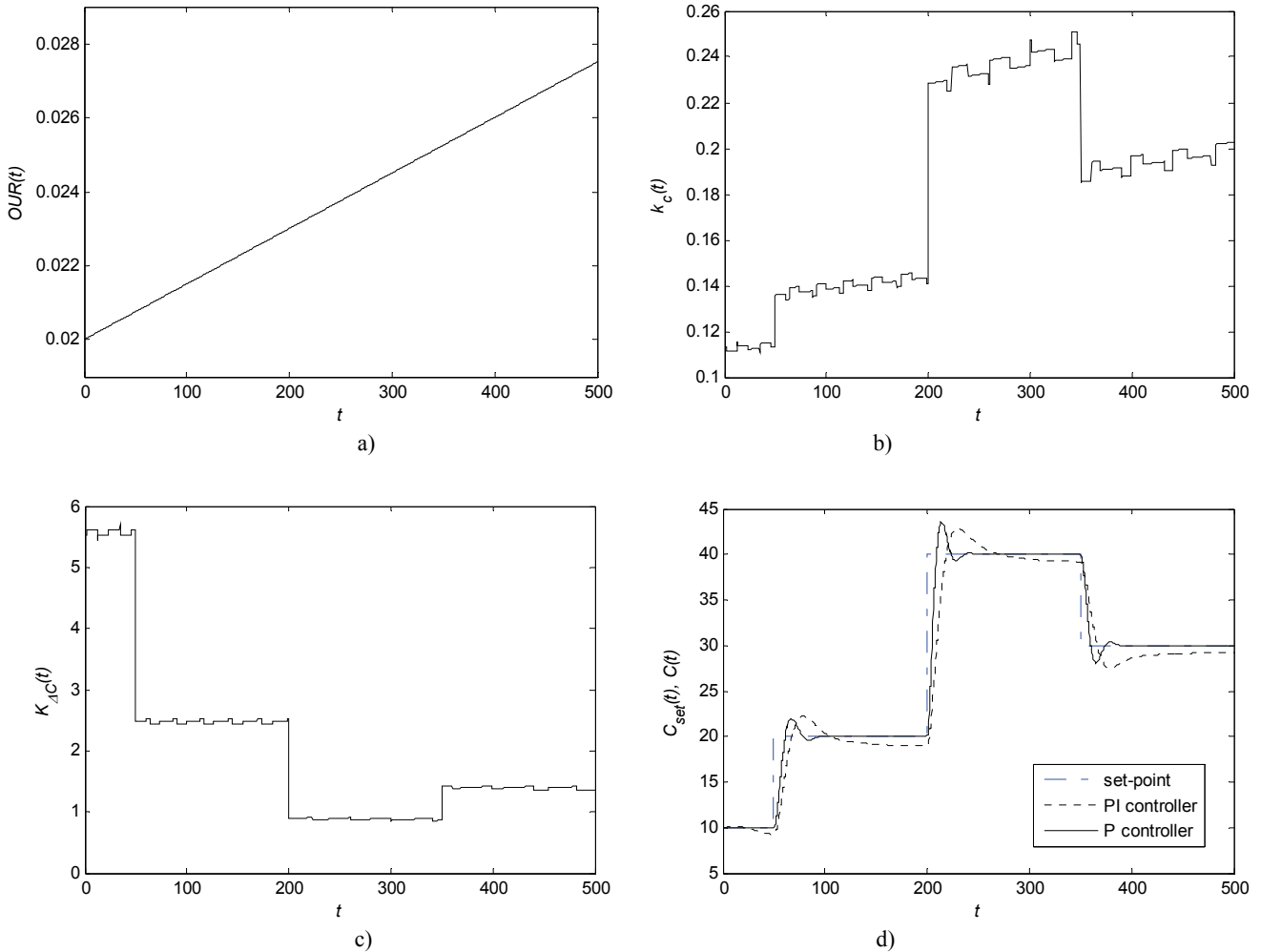

Fig. 6. Simulated performances of the DOC adaptive control systems at set-point step changes and time-varying oxygen uptake rate: OUR (a), adaptation of P controller gain (b), adaptation of transfer coefficient between set-point and corrective term (c), DOC controlled at set point (d)

In the simulation experiments, disturbances of the DOC set-point step changes under time-varying oxygen uptake rate were applied. Step changes of the set-point from 10 % to 20 %, from 20 % to 40 % and from 40 % to 30 % were introduced at time points $t = 50$ sec, $t = 200$ sec, and $t = 350$ sec, respectively. Time-varying trajectory of $OUR(t)$, presented in Fig. 6 (a), is chosen to simulate close to realistic operating conditions at batch fermentations. Adaptation of P controller gain and the transfer coefficient between the set-point and the corrective term to time-varying operating conditions is demonstrated in Fig. 6 (b) and Fig. 6 (c), respectively. Responses of the controlled DOC to the set-point changes are given in Fig. 6 (d). The solid line demonstrates responses of the adaptive P control system with steady-state error compensation, the dotted line – responses of the adaptive PI control system.

The simulation results demonstrate that the DOC adaptive P control system with steady-state error compensation outperforms the adaptive PI control system in respect of rise time, settling time and integral of absolute value of the error.

Conclusions

Performances of P and PD controllers in control systems with steady-state error compensation are investigated and compared with those of PI and PID controllers in ordinary feed-back control systems. The investigation is carried out by computer simulation of the control system performances in controlling processes with various dynamic parameters. The controllers were tuned to minimize the ITAE criterion that was used as a measure of control quality. The simulation results demonstrate that the P and PD controllers in control systems with steady-state error compensation outperform the PI and PID controllers in ordinary feed-back control systems, respectively. Statistical tests prove that the observed differences in the ITAE criterion values are significant.

Performance of P controller in the system with steady-state error compensation and adaptation of controller gain was investigated by controlling the dissolved oxygen concentration in batch operating mode bioreactor at set-point step changes and permanent change in process dynamics. The simulation results show that the system with adaptive P controller and steady-state error

compensation provides shorter rise and settling times compared with those of adaptive PI controller.

The investigation results prove that application of P and PD control systems with the steady-state error compensation is worthwhile.

References

1. **Astrom K. J., Hagglund T.** PID Controllers: Theory, Design and Tuning, 2nd ed. – Instrument Society of America, Research Triangle Park, NC, 1995. – 343 p.
2. **Smith C. A., Corripio A. B.** Principles and Practice of Automatic Process Control, 3rd ed. – John Wiley & Sons Inc., 2006. – 563 p.
3. **Krejcar O., Spicka I., Frischer R.** Implementation of Full-Featured PID Regulator in Microcontrollers // *Electronics and Electrical Engineering*. – Kaunas: Technologija, 2011. – No. 7(113). – P. 77–82. DOI: 10.5755/j01.eee.113.7.617.
4. **Schiller J. J., Srinivasan R., Spiegel A., Murray R.** Schaum's Outlines: Probability and Statistics, 3rd ed. – McGraw-Hill Professional Publishing, 2008. – 433 p.
5. **Levišauskas D.** An Algorithm for Adaptive Control of Dissolved Oxygen Concentration in Batch Culture // *Biotechnology Techniques*. – Kluwer Academic Publishers, 1995. – Vol. 9. – No. 2. – P. 85–90.
6. **Nielsen J., Villadsen J., Liden G.** Bioreaction Engineering Principles, 2nd ed. – Kluwer Academic/Plenum Publishers, 2003. – 528 p.

Received 2012 01 05

Accepted after revision 2012 02 28

D. Levisauskas, T. Tekorius. Investigation of P and PD Controllers' Performance in Control Systems with Steady-State Error Compensation // *Electronics and Electrical Engineering*. – Kaunas: Technologija, 2012. – No. 5(121). – P. 63–68.

In the paper, performance of P and PD controllers in control systems with steady-state error compensation is investigated and compared with a performance of ordinary PI and PID control systems. The investigation is carried out by computer simulation of the control systems in controlling the processes with various dynamic parameters. Performance of P controller is also investigated by operating in the control system with steady-state error compensation and the control system adaptation to time-varying operating conditions. The investigation results show that that the P and PD controllers in the systems with steady-state error compensation outperform the ordinary PI and PID control systems, respectively. Ill. 6, bibl. 6, tabl. 1 (in English; abstracts in English and Lithuanian).

D. Levišauskas, T. Tekorius. P ir PI reguliatorių veikimo tyrimas valdymo sistemose su kompensuojama statine paklaida // *Elektronika ir elektrotechnika*. – Kaunas: Technologija, 2012. – Nr. 5(121). – P. 63–68.

Straipsnyje tiriamas P ir PD reguliatorių veikimas valdymo sistemose su kompensuojama statine paklaida. Šių sistemų veikimas palygintas su įprastų PI ir PID valdymo sistemų veikimu. Tyrimas atliktas skaitmeninio modeliavimo būdu valdant procesus su įvairiomis dinaminėmis savybėmis. Taip pat ištirtas P reguliatoriaus veikimas valdymo sistemoje su kompensuojama statine paklaida, prisitaikančioje prie laikui bėgant kintančių proceso dinaminų savybių. Tyrimo rezultatai rodo, kad P ir PD reguliatoriai sistemose su kompensuojama statine paklaida leidžia pasiekti geresnius valdymo kokybės rodiklius, palyginti su įprastinėmis PI ir PID valdymo sistemomis. Il. 6, bibl. 6, lent. 1 (anglų kalba; santraukos anglų ir lietuvių k.).