

Autonomous Duffing–Holmes Type Chaotic Oscillator

A. Tamaševičius, S. Bumelienė

*Plasma Phenomena and Chaos Laboratory, Semiconductor Physics Institute,
A. Goštauto str. 11, LT-01108 Vilnius, Lithuania, phone: +370 5 2619589; e-mail: tamasev@pfi.lt*

R. Kirvaitis

*Department of Electronic Systems, Faculty of Electronics, Vilnius Gediminas Technical University,
Naugarduko str. 41, LT-03227 Vilnius, Lithuania, phone: +370 5 2745005; e-mail: raimundas.kirvaitis@adm.vgtu.lt*

G. Mykolaitis

*Department of Physics, Faculty of Fundamental Sciences, Vilnius Gediminas Technical University,
Saulėtekio av. 11, LT-10223 Vilnius, Lithuania, phone: +370 5 2619589; e-mail: gytis@pfi.lt*

E. Tamaševičiūtė

*Department of General Physics and Spectroscopy, Faculty of Physics, Vilnius University,
Saulėtekio av. 9, Vilnius, LT-10222, Lithuania, phone: +370 629 19788; e-mail: elena.tamaseviciute@ff.vu.lt*

E. Lindberg

*DTU Elektro Department, Electronics & Signalprocessing, 348, Technical University of Denmark,
DK-2800 Lyngby, Denmark, phone: +45 4525 3650; e-mail: el@elektro.dtu.dk*

Introduction

The Duffing–Holmes nonautonomous oscillator is a classical example of a nonlinear dynamical system exhibiting complex also chaotic behaviour [1–3]. It is given by the second order differential equation with an external periodic drive term:

$$\frac{d^2x}{dt^2} + b \frac{dx}{dt} - x + x^3 = a \sin \omega t. \quad (1)$$

Three different techniques are used to solve the Duffing–Holmes equation and to process its solutions electronically. *The first* approach is a hybrid one making use of integration the equation in a digital processor and of the digital-to-analogue conversion of the digital output for its further analogue processing, analysis and display [4, 5]. *The second* method employs purely analogue hardware based on analogue computer design [6–9]. For example, analogue computer has been used to simulate Eq. (1) and to demonstrate the effect of scrambling chaotic signals in linear feedback shift registers [6–8]. Later analogue computer has been suggested for demonstration of chaos from Eq. (1) for the undergraduate students [9]. *The third* technique is based on building some specific analogue electrical circuit imitating dynamical behaviour of Eq. (1). The Young–Silva oscillator [10] and used to demonstrate the effect of resonant perturbations for inducing chaos [11] is an example. Recently the Young–Silva circuit has been essentially modified and used to test the control methods

for unstable periodic orbits [12, 13] and unstable steady states [14] of dynamical systems. The modified version of the Young–Silva oscillator has been characterized both numerically and experimentally in [15].

Evidently the first and the second techniques are rather general and can be applied to other differential equations as well. In contrast, the third approach is limited to a specific equation. Despite this restriction the “intrinsic” electrical circuits have an attractive advantage due to their extreme simplicity and cheapness.

One may think of such analogue electrical circuits as of analogue computers. This is true from a mathematical and physical point of view in the sense that the underlying equations are either exactly the same or very similar also that the dynamical variables in the both cases are represented by real electrical voltages and/or currents. However, the circuit architecture of an analogue computer, compared to an “intrinsic” nonlinear circuit, is rather different. Any analogue computer is a standard collection of the following main processing blocks: inverting RC integrators, inverting adders, inverting and non-inverting amplifiers, multipliers, and piecewise linear nonlinear units. Meanwhile the specific analogue circuits comprise only small number of electrical components: resistors, capacitors, inductors, and semiconductor diodes. In addition, they may include a single operational amplifier (in some cases several amplifiers).

In this paper, we introduce, as an alternative for the nonautonomous Eq. (1), an autonomous version of the Duffing type oscillator given by

$$\begin{aligned} \frac{d^2x}{dt^2} - b \frac{dx}{dt} - x + x^3 + kz &= 0, \\ \frac{dz}{dt} &= \omega_f \left(\frac{dx}{dt} - z \right) \end{aligned} \quad (2)$$

or equivalently by a set of three first order equations

$$\begin{aligned} \frac{dx}{dt} &= y, \\ \frac{dy}{dt} &= x - x^3 + by - kz, \\ \frac{dz}{dt} &= \omega_f (y - z). \end{aligned} \quad (2a)$$

Here z is the third independent dynamical variable, ω_f is its characteristic rate, and k is the feedback coefficient. We emphasize in Eq. (2) an opposite sign of the damping term, compared to Eq. (1). The negative damping, $-b dx/dt$ in Eq. (2), or $+by$ in Eq. (2a) yields additional spiral instability. Also we propose a specific electrical circuit imitating solutions of Eq. (2a).

Electronic circuitry

The novel *autonomous* circuit is presented in Fig. 1.

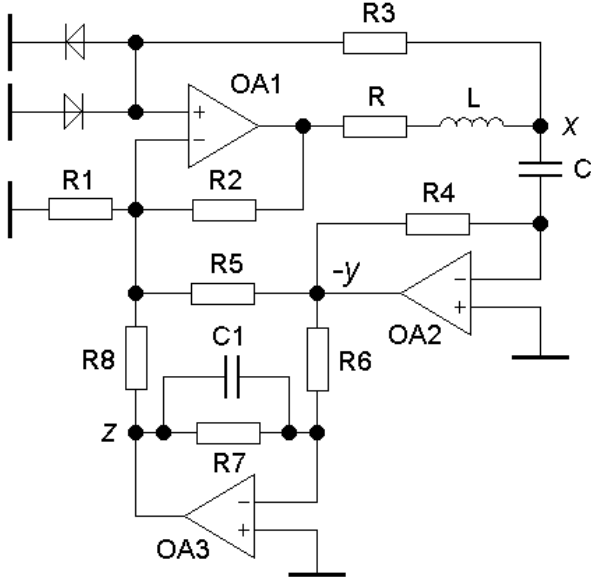

Fig. 1. Circuit implementation of the *autonomous* Duffing type oscillator. Any of the nodes lettered as 'x', '-y' or 'z' can be taken for the output

The stage containing the operational amplifier OA1, the diodes, the resistors R1, R2 and R3 is exactly the same as in the nonautonomous oscillator [15]. The autonomous oscillator lacks the external periodic drive source, but includes two additional linear feedback loops. The circuit composed of the OA2 based stage and the resistor R5 introduce the positive feedback loop, specifically negative damping in Eq. (2). While the circuit including the OA2–OA3 stages (note a capacitor C1 in the latter stage) and the resistor R8 compose the inertial negative feedback, specifically the inertial positive damping term kz in Eq. (2).

Simulation results

The oscillator in Fig. 1 has been simulated using the *ELECTRONICS WORKBENCH* package (*SPICE* based software) and the results are shown in Figs. 2–4. The following element values have been used in the simulation: $L = 19$ mH, $C = 470$ nF, $C1 = 20$ nF, $R = 20$ Ω , $R1 = 30$ k Ω , $R2 = 10$ k Ω , $R3 = 30$ k Ω , $R4 = 820$ Ω , $R5 = 75$ k Ω , $R6 = R7 = 10$ k Ω , $R8 = 20$ k Ω . The OA1 to OA3 are the LM741 type or similar operational amplifiers, the diodes are the 1N4148 type or similar general-purpose devices.

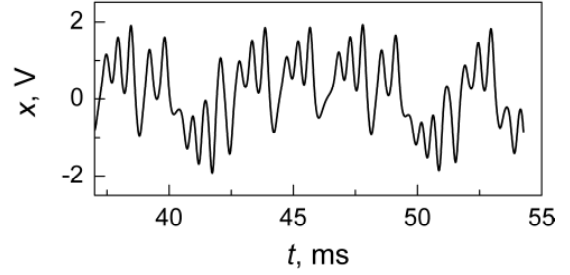

Fig. 2. Snapshot of typical chaotic waveform of $x(t)$ from the autonomous Duffing type oscillator

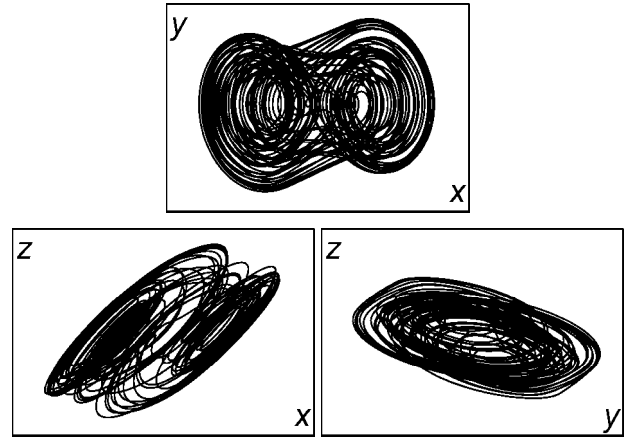

Fig. 3. Simulated phase portraits $[x-y]$, $[x-z]$, $[y-z]$

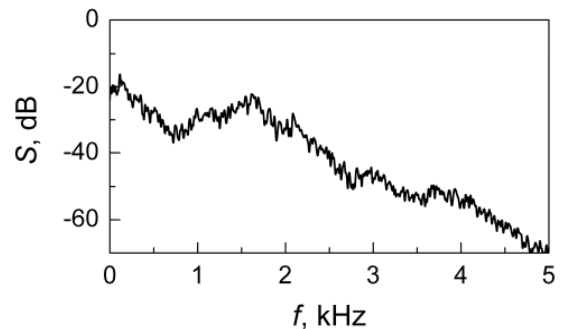

Fig. 4. Simulated power spectrum S from the variable $x(t)$

Hardware Experiments

The autonomous oscillator has been built using the elements described in the previous section. Typical experimental results are presented in Fig. 5–7.

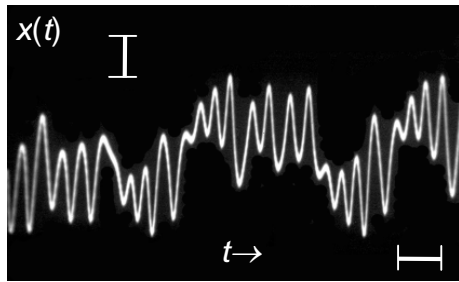

Fig. 5. Experimental snapshot of chaotic waveform $x(t)$. Horizontal scale 2 ms/div. Vertical scale 1 V/div. Element values are the same as in the previous section, except $R5 = 68 \text{ k}\Omega$

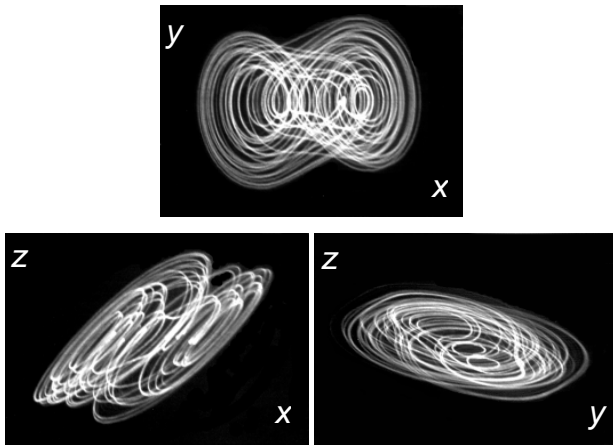

Fig. 6. Experimental phase portraits $[x-y]$, $[x-z]$, $[y-z]$. Element values are the same as in the previous section, except $R5 = 68 \text{ k}\Omega$

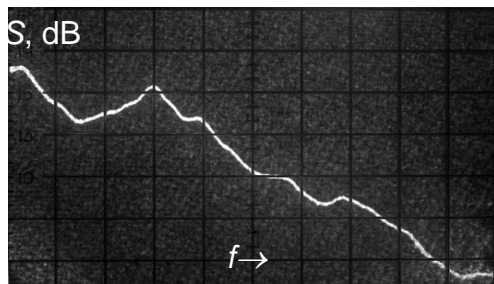

Fig. 7. Experimental power spectrum S from the output signal $x(t)$. Frequency range 0 to 5 kHz. Horizontal scale 500 Hz/div., resolution 100 Hz. Vertical scale 10 dB/div. Circuit element values are the same as in the previous section, except $R5 = 68 \text{ k}\Omega$

Concluding remarks

We have designed and built a novel Duffing type autonomous 3rd-order chaotic oscillator. In comparison with the common nonautonomous Duffing–Holmes type oscillator [15] the autonomous circuit has an internal positive feedback loop instead of an external periodic drive source. In addition, it is supplemented with an RC inertial damping loop providing negative feedback. The circuit has been investigated both numerically and experimentally. The main characteristics, including the time series, phase portraits, and power spectra have been calculated using the SPICE based software, also taken experimentally. Fairly good agreement between the simulation and the hardware

experimental results is observed (Fig. 3–7). Some discrepancy (about 10%) between the model and the hardware prototype, namely $R5 = 75 \text{ k}\Omega$ in the model (Fig. 3–5) and $R5 = 68 \text{ k}\Omega$ in the experimental circuit (Fig. 6–7) can be explained in the following way. The inductive element in the model is an ideal device in the sense that its $L = \text{const}$. Meanwhile the inductance of a real inductor, e.g. a coil wound on a ferrite toroidal core has a slight dependence on the current through it: $L = L(I)$.

We note that the structure of the proposed oscillator is rather different in comparison to many other 3rd-order autonomous chaotic oscillators described so far. The basic unit of the RC Wien-bridge [16–18] and LC tank [19–21] based oscillators is the 2nd-order *linear* unstable resonator. An additional degree of freedom required for chaos is introduced by supplementing the resonator with the 1st-order inertial *nonlinear* damping loop [16–21]. The same approach of building chaotic oscillators is used in higher order circuits [22–24] (some of the design principles are overviewed in a book chapter [25]). In contrast, the oscillator described in this paper contains a *nonlinear* unstable resonator and an inertial *linear* damping loop.

References

1. **Ott E.** Chaos in Dynamical Systems. – Cambridge University Press. – 1993.
2. **Hilborn R. C.** Chaos and Nonlinear Dynamics: An Introduction for Scientists and Engineers. – Oxford University Press. – 2006.
3. **Cvitanović P. et al.** Chaos: Classical and Quantum. – Niels Bohr Institute, Copenhagen. – 2008 [interactive]. Accessed at: <http://ChaosBook.org>.
4. **Namajūnas A., Tamaševičius A.** An Optoelectronic Technique for Estimating Fractal Dimensions from Dynamical Poincaré Maps // IFIP Transactions A: Computer Science and Technology. – 1994. – Vol. A-41. – P. 289–293.
5. **Namajūnas A., Tamaševičius A.** Simple Laboratory Instrumentation for Measuring Pointwise Dimensions from Chaotic Time Series // Review of Scientific Instruments. – 1994. – Vol. 65. – P. 3032–3033.
6. **Namajūnas A., Tamaševičius A., Čenys A., Anagnostopoulos A. N.** Whitening Power Spectra of Chaotic Signals // Proceedings of the 7th International Workshop on Nonlinear Dynamics of Electronic Systems. – Rønne, Bornholm, Denmark. – 1999. – P. 137–140.
7. **Namajūnas A., Tamaševičius A., Mykolaitis G., Čenys A.** Spectra Transformation of Chaotic Signals // Lithuanian Journal of Physics. – 2000. – Vol. 40. – P. 134–139.
8. **Namajūnas A., Tamaševičius A., Mykolaitis G., Čenys A.** Smoothing Chaotic Spectrum of Nonautonomous Oscillator // Nonlinear Phenomena in Complex Systems. – 2000. – Vol. 3. – P. 188–191.
9. **Jones B. K., Trefan G.** The Duffing Oscillator: A Precise Electronic Analog Chaos Demonstrator for the Undergraduate Laboratory // American Journal of Physics. – 2001. – Vol. 69. – P. 464–469.
10. **Silva C. P., Young A. M.** High Frequency Anharmonic Oscillator for the Generation of Broadband Deterministic Noise. – U.S. Patent No. 6,127,899. – October 3, 2000.
11. **Kandangath A., Krishnamoorthy S., Lai Y.-C., Gaudet J. A.** Inducing Chaos in Electronic Circuits by Resonant Perturbations // IEEE Transactions on Circuits and Systems –

- I: Fundamental Theory and Applications. – 2007. – Vol. 54. – P. 1109–1119.
12. **Tamaševičius A., Tamaševičiūtė E., Mykolaitis G., Bumelienė S.** Stabilisation of Unstable Periodic Orbit in Chaotic Duffing–Holmes Oscillator by Second Order Resonant Negative Feedback // *Lithuanian Journal of Physics*. – 2007. – Vol. 47. – P. 235–239.
 13. **Tamaševičius A., Mykolaitis G., Pyragas V., Pyragas K.** Delayed Feedback Control of Periodic Orbits without Torsion in Nonautonomous Chaotic Systems: Theory and Experiment // *Physical Review E*. – 2007. – Vol. 76, No. 2. – P. 026203.
 14. **Tamaševičius A., Tamaševičiūtė E., Mykolaitis G., Bumelienė S.** Switching from Stable to Unknown Unstable Steady States of Dynamical Systems // *Physical Review E*. – 2008. – Vol. 78, No. 2. – P. 026205.
 15. **Tamaševičiūtė E., Tamaševičius A., Mykolaitis G., Bumelienė S., Lindberg E.** Analogue Electrical Circuit for Simulation of the Duffing–Holmes Equation // *Nonlinear Analysis: Modelling and Control*. – 2008. – Vol. 13. – P. 241–252.
 16. **Namajūnas A., Tamaševičius A.** Modified Wien–Bridge Oscillator for Chaos // *Electronics Letters*. – 1995. – Vol. 31, No 5. – P. 335–336.
 17. **Namajūnas A., Tamaševičius A.** RC Chaotic Oscillator // *Electronics and Electrical Engineering*. – Kaunas: Technologija, 1996. – No. 1(5). – P. 40–42 (in Lithuanian).
 18. **Namajūnas A., Tamaševičius A.** Simple RC Chaotic Oscillator // *Electronics Letters*. – 1996. – Vol. 32, No. 11. – P. 945–946.
 19. **Pikšrys R. A., Pyragas K. A., Tamaševičius A. V.** Diagrams for Transforming LC–Autogenerator into Noise Generator // *Radiotekhnika*. – 1986. – No. 9. – P. 43–45 (in Russian) (for English translation see *Telecommunications and Radioengineering*. – 1986. – No. 9).
 20. **Tamaševičius A.** Reproducible Analogue Circuit for Chaotic Synchronisation // *Electronics Letters*. – 1997. – Vol. 33, No. 13. – P. 1105–1106.
 21. **Tamaševičius A., Mykolaitis G., Pyragas V., Pyragas K.** Simple Chaotic Oscillator for Educational Purposes // *European Journal of Physics*. – 2005. – Vol. 26. – P. 61–63.
 22. **Nishio Y., Mori S., Saito T.** An Approach Toward Higher Dimensional Autonomous Chaotic Circuits // *Proceedings International Seminar on Nonlinear Circuits and Systems*. – Moscow, Russia. – 1992. – P. 60–69.
 23. **Tamaševičius A., Namajūnas A., Čenys A.** Simple 4D Chaotic Oscillator // *Electronics Letters*. – 1996. – Vol. 32, No. 11. – P. 957–958.
 24. **Tamaševičius A., Čenys A., Mykolaitis G., Namajūnas A., Lindberg E.** Hyperchaotic Oscillator with Gyrotors // *Electronics Letters*. – 1997. – Vol. 33, No. 7. – P. 542–544.
 25. **Lindberg E., Murali K., Tamaševičius A.** Chaotic Oscillators – Design Principles. Chapter 1 of *Chaos in Circuits and Systems*. – Eds. G. Chen and T. Ueta. – World Scientific Pb. – 2002. – P. 1–21.

Received 2009 02 06

A. Tamaševičius, S. Bumelienė, R. Kirvaitis, G. Mykolaitis, E. Tamaševičiūtė, E. Lindberg. Autonomous Duffing–Holmes Type Chaotic Oscillator // Electronics and Electrical Engineering. – Kaunas: Technologija, 2009. – No. 5(93). – P. 43–46.

A novel Duffing–Holmes type autonomous chaotic oscillator is described. In comparison with the well-known nonautonomous Duffing–Holmes circuit it lacks the external periodic drive, but includes two extra linear feedback subcircuits, namely a direct positive feedback loop, and an inertial negative feedback loop. In contrast to many other autonomous chaotic oscillators, including linear unstable resonators and nonlinear damping loops, the novel circuit is based on nonlinear resonator and linear damping loop in the negative feedback. SPICE simulation and hardware experimental investigations are presented. Fairly good agreement between numerical and experimental results is observed. Ill. 7, bibl. 25 (in English; summaries in English, Russian and Lithuanian).

A. Тамашевичюс, С. Бумялене, Р. Кирвайтис, Г. Миколайтис, Е. Тамашевичюте, Э. Линдберг. Автономный хаотический генератор типа Дуффинга–Холмса // Электроника и электротехника. – Каунас: Технология, 2009. – № 5(93). – С. 43–46.

Описывается новый хаотический автогенератор типа Дуффинга–Холмса. По сравнению с общеизвестной неавтономной цепью Дуффинга–Холмса в предлагаемом автогенераторе отсутствует источник внешнего периодического возбуждения, но введены две дополнительные линейные цепи обратной связи: цепочка прямой положительной и цепочка инерционной отрицательной обратной связи. В отличие от многих других хаотических автогенераторов, содержащих линейные неустойчивые резонаторы и нелинейные демпфирующие цепочки, основой описываемой цепи является нелинейный резонатор и линейное демпфирующее звено в цепи обратной связи. Представляются результаты вычислительного и экспериментального исследования. Ил. 7, библи. 25 (на английском языке; рефераты на английском, русском и литовском яз.).

A. Tamaševičius, S. Bumelienė, R. Kirvaitis, G. Mykolaitis, E. Tamaševičiūtė, E. Lindberg. Autonominis Duffingo–Holmeso chaotinis generatorius // Elektronika ir elektrotechnika. – Kaunas: Technologija, 2009. – Nr. 5(93). – P. 43–46.

Aprašomas naujas Duffingo–Holmeso chaotinių virpesių autogeneratorius. Palyginti su gerai žinomu neautonominiu Duffingo–Holmeso generatoriumi, jame nėra išorinio periodinio žadinimo šaltinio. Vietoj jo įtaisytos dvi papildomos tiesinės grįžtamojo ryšio grandinės: tiesioginio teigiamojo ryšio grandinė ir inertinio neigiamojo ryšio grandinė. Skirtingai nuo daugelio kitų chaotinių autogeneratorių, turinčių tiesinius nestabilius rezonatorius ir netiesines slopinimo grandines, aprašomojoje grandinėje naudojamas netiesinis rezonatorius ir tiesinė slopinimo grandinė. Pateikiami skaitinio modeliavimo ir eksperimentinio tyrimo rezultatai tarpusavyje gana gerai sutampa. Il. 7, bibl. 25 (anglų kalba; santraukos anglų, rusų ir lietuvių k.).